

310SE and 315SE Backhoe Loaders Operation and Test

TECHNICAL MANUAL
TM1608 20SEP06 (ENGLISH)



For complete service information also see:

310SE and 315SE Backhoe Loader Repair (Complete)	TM1609
310E and 315SE Backhoe Loader Operation and Test (Complete)	TM1608
310SE Backhoe Loader and 315SE Sideshift Backhoe Loader.....	OMT184377
POWERTECH® 4.5L (4045) and 6.8L (6068) Engine.....	CTM104
POWERTECH® 4.5L & 6.8L Diesel Engines Mechanical Fuel Systems	CTM207
Alternators and Starting Motors	CTM77
Front Wheel Drive Axles APL-2025	CTM4509

**Worldwide Construction
And Forestry Division**
LITHO IN U.S.A.

Introduction

Foreword

This manual is written for an experienced technician. Essential tools required in performing certain service work are identified in this manual and are recommended for use.

Live with safety: Read the safety messages in the introduction of this manual and the cautions presented throughout the text of the manual.

 This is the safety-alert symbol. When you see this symbol on the machine or in this manual, be alert to the potential for personal injury.

Technical manuals are divided in two parts: repair and operation and tests. Repair sections tell how to repair the components. Operation and tests sections help you identify the majority of routine failures quickly.

Information is organized in groups for the various components requiring service instruction. At the beginning of each group are summary listings of all applicable essential tools, service equipment and tools, other materials needed to do the job, service parts kits, specifications, wear tolerances, and torque values.

Technical Manuals are concise guides for specific machines. They are on-the-job guides containing only the vital information needed for diagnosis, analysis, testing, and repair.

Fundamental service information is available from other sources covering basic theory of operation, fundamentals of troubleshooting, general maintenance, and basic type of failures and their causes.

See DB1990 Service Publications Catalog to order a complete Technical Manual (TM) or a Technical Manual Section (TMS). A complete Operation and Test manual includes the following sections:

- Section 9000 General Information
- Section 9005 Operational Checkout Procedure
- Section 9010 Engine
- Section 9015 Electrical System
- Section 9020 Power Train
- Section 9025 Hydraulics
- Section 9031 Air Conditioning

TX,INTR,RR7339 -19-15FEB00-1/1



John Deere Dealers

IMPORTANT: Please remove this page and route through your service department.

Listed below is a brief explanation of "WHAT" was change and "WHY" it was changed.

These sectionalize manuals were revised to include the following changes

1. Section 9000:
To include any specifications, oil capacity and safety updates.
2. Section 9005:
To include miscellaneous updates.
3. Section 9010:
To include miscellaneous updates.
4. Section 9015:
To include serial number for tachometer, updates for selective flow control valve harness, timer relay updates, and miscellaneous updates.
5. Section 9020:
To add keys and legend to foldout pages and control valves in theory of operation section. To add miscellaneous updates.
6. Section 9025:
To update cycle times, change ride control accumulator specifications and miscellaneous updates.
7. Section 9031:
To update miscellaneous nomenclature.

Technical Information Feedback Form

We need your help to continually improve our technical publications. Please copy this page and FAX or mail your comments, ideas and improvements.

SEND TO: John Deere Dubuque Works
P.O. Box 538
Attn: Publications Supervisor, Dept. 303
Dubuque, IA 52004-0538

FAX NUMBER: 563-589-5800

Ideas, Comments (Please State Page Number): _____

OVERALL, how would you rate the quality of this publication? (Check one)

	Poor		Fair		Good		Very Good		Excellent	
1	2	3	4	5	6	7	8	9	10	

Company Name: _____
Technician Name: _____
Address: _____
Phone: _____
Fax No.: _____
Dealer Acct. No.: _____

THANK YOU!

Contents

SECTION 9000—General Information

- Group 01—Safety Information
- Group 02—General Specifications
- Group 03—Torque Values
- Group 04—Fuels and Lubricants

9000

SECTION 9005—Operational Checkout Procedure

- Group 10—Operational Checkout Procedure

9005

SECTION 9010—ENGINE

- Group 05—Theory of Operation
- Group 15—Diagnostic Information
- Group 20—Adjustments
- Group 25—Tests

9010

SECTION 9015—Electrical System

- Group 05—System Information
- Group 10—System Diagrams
- Group 15—Sub-System Diagnostics
- Group 20—References

9015

SECTION 9020—Power Train

- Group 05—Theory of Operation
- Group 15—System Diagnostic Information
- Group 20—Adjustments
- Group 25—Tests

9020

SECTION 9025—Hydraulic System

- Group 05—Theory of Operation
- Group 15—Diagnostic Information
- Group 20—Adjustments
- Group 25—Tests

9025

SECTION 9031—Heating And Air Conditioning

- Group 05—Theory Of Operation
- Group 10—System Operational Checks
- Group 15—Diagnostic Information
- Group 20—Adjustments
- Group 25—Test

9031

INDX

All information, illustrations and specifications in this manual are based on the latest information available at the time of publication. The right is reserved to make changes at any time without notice.

COPYRIGHT © 2006
DEERE & COMPANY
Moline, Illinois
All rights reserved
A John Deere ILLUSTRATION® Manual
Previous Editions
Copyright © 1997, 1998, 2000

Contents

9000

9005

9010

9015

9020

9025

9031

INDX

Section 9000

General Information

Contents

Page	Page
Group 01—Safety Information	
Handle Fluids Safely—Avoid Fires	9000-01-1
Prevent Battery Explosions.....	9000-01-1
Prepare for Emergencies	9000-01-1
Prevent Acid Burns.....	9000-01-2
Handle Chemical Products Safely.....	9000-01-3
Avoid High-Pressure Fluids	9000-01-3
Park Machine Safely.....	9000-01-4
Support Machine Properly	9000-01-4
Wear Protective Clothing.....	9000-01-4
Work in Clean Area.....	9000-01-5
Service Machines Safely	9000-01-5
Work In Ventilated Area.....	9000-01-5
Illuminate Work Area Safely	9000-01-5
Replace Safety Signs	9000-01-6
Use Proper Lifting Equipment.....	9000-01-6
Remove Paint Before Welding or Heating.....	9000-01-7
Avoid Heating Near Pressurized Fluid Lines	9000-01-7
Keep ROPS Installed Properly	9000-01-8
Service Tires Safely.....	9000-01-8
Practice Safe Maintenance.....	9000-01-9
Use Proper Tools.....	9000-01-9
Dispose of Waste Properly	9000-01-10
Live With Safety.....	9000-01-10
Group 02—General Specifications	
310SE and 315SE Specifications	9000-02-1
310SE and 315SE Backhoe Loader Dimensions	9000-02-2
310SE and 315SE Backhoe Loader— Specifications.	9000-02-9
310SE and 315SE Backhoe Loader—Other Information.	9000-02-13
310SE and 315SE Backhoe Loader Weight	9000-02-14
310SE and 315SE Backhoe and Loader Buckets	9000-02-15
310SE and 315SE Backhoe Loader Drain and Refill Capacities	9000-02-16
310SE And 315SE Backhoe Loader Lifting Capacities—Standard Dipperstick	9000-02-17
310SE And 315SE Backhoe Loader Lifting Capacities—Extendible Dipperstick (Retracted).....	9000-02-18
310SE And 315SE Backhoe Loader Lifting Capacities— Extendible Dipperstick (Extended).....	9000-02-19
Group 03—Torque Values	
Hardware Torque Specifications.....	9000-03-1
ROPS Torque Specifications	9000-03-1
Metric Bolt and Screw Torque Values.....	9000-03-2
Additional Metric Cap Screw Torque Values	9000-03-3
Unified Inch Bolt and Screw Torque Values	9000-03-5
Check Oil Lines And Fittings	9000-03-6
O-Ring Groove Connections.....	9000-03-7
Service Recommendations For Flat Face O-Ring Seal Fittings	9000-03-8
Service Recommendations for O-Ring Boss Fittings	9000-03-9
Service Recommendations for Metric Series Four Bolt Flange Fitting	9000-03-11
Service Recommendations For Inch Series Four Bolt Flange Fittings	9000-03-12
Group 04—Fuels and Lubricants	
Diesel Fuel.....	9000-04-1
Diesel Engine Coolant	9000-04-2
Low Sulfur Diesel Fuel Conditioner	9000-04-3
Diesel Fuel Storage	9000-04-4
Do Not Use Galvanized Containers.....	9000-04-5
Fuel Tank	9000-04-5
Diesel Engine Oil	9000-04-6
Transmission, Axles and Mechanical Front Wheel Drive Oil	9000-04-7
Hydraulic Oil.....	9000-04-8
Grease	9000-04-9
Grease For Extendible Dipperstick, Sideshift Frame, And Stabilizer Leg Wear Strips	9000-04-9
Alternative and Synthetic Lubricants	9000-04-10
Lubricant Storage.....	9000-04-10
Mixing of Lubricants.....	9000-04-11

Contents

9000

Handle Fluids Safely—Avoid Fires

When you work around fuel, do not smoke or work near heaters or other fire hazards.

Store flammable fluids away from fire hazards. Do not incinerate or puncture pressurized containers.

Make sure machine is clean of trash, grease, and debris.

Do not store oily rags; they can ignite and burn spontaneously.



TS227 -UN-23AUG88

DX,FLAME -19-29SEP98-1/1

Prevent Battery Explosions

Keep sparks, lighted matches, and open flame away from the top of battery. Battery gas can explode.

Never check battery charge by placing a metal object across the posts. Use a volt-meter or hydrometer.

Do not charge a frozen battery; it may explode. Warm battery to 16°C (60°F).



TS204 -UN-23AUG88

DX,SPARKS -19-03MAR93-1/1

Prepare for Emergencies

Be prepared if a fire starts.

Keep a first aid kit and fire extinguisher handy.

Keep emergency numbers for doctors, ambulance service, hospital, and fire department near your telephone.

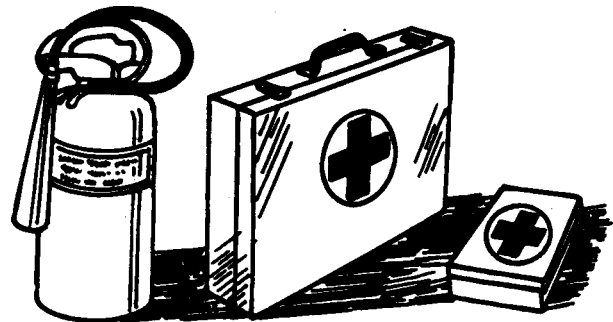

TS291 -UN-23AUG88

DX,FIRE2 -19-03MAR93-1/1

9000
01
2

Prevent Acid Burns

Sulfuric acid in battery electrolyte is poisonous. It is strong enough to burn skin, eat holes in clothing, and cause blindness if splashed into eyes.

Avoid the hazard by:

1. Filling batteries in a well-ventilated area.
2. Wearing eye protection and rubber gloves.
3. Avoiding breathing fumes when electrolyte is added.
4. Avoiding spilling or dripping electrolyte.
5. Use proper jump start procedure.

If you spill acid on yourself:

1. Flush your skin with water.
2. Apply baking soda or lime to help neutralize the acid.
3. Flush your eyes with water for 15—30 minutes. Get medical attention immediately.

If acid is swallowed:

1. Do not induce vomiting.
2. Drink large amounts of water or milk, but do not exceed 2 L (2 quarts).
3. Get medical attention immediately.

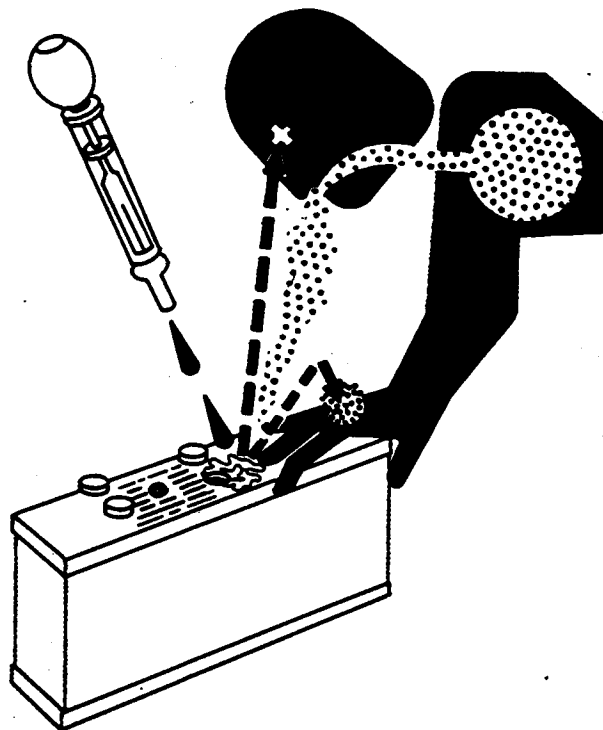

TS203 -JUN-23AUG88

DX,POISON -19-21APR93-1/1

Handle Chemical Products Safely

Direct exposure to hazardous chemicals can cause serious injury. Potentially hazardous chemicals used with John Deere equipment include such items as lubricants, coolants, paints, and adhesives.

A Material Safety Data Sheet (MSDS) provides specific details on chemical products: physical and health hazards, safety procedures, and emergency response techniques.

Check the MSDS before you start any job using a hazardous chemical. That way you will know exactly what the risks are and how to do the job safely. Then follow procedures and recommended equipment.

(See your John Deere dealer for MSDS's on chemical products used with John Deere equipment.)



T51132 -UN-26NOV90

DX,MSDS,NA -19-03MAR93-1/1

Avoid High-Pressure Fluids

Escaping fluid under pressure can penetrate the skin causing serious injury.

Avoid the hazard by relieving pressure before disconnecting hydraulic or other lines. Tighten all connections before applying pressure.

Search for leaks with a piece of cardboard. Protect hands and body from high pressure fluids.

If an accident occurs, see a doctor immediately. Any fluid injected into the skin must be surgically removed within a few hours or gangrene may result. Doctors unfamiliar with this type of injury should reference a knowledgeable medical source. Such information is available from Deere & Company Medical Department in Moline, Illinois, U.S.A.

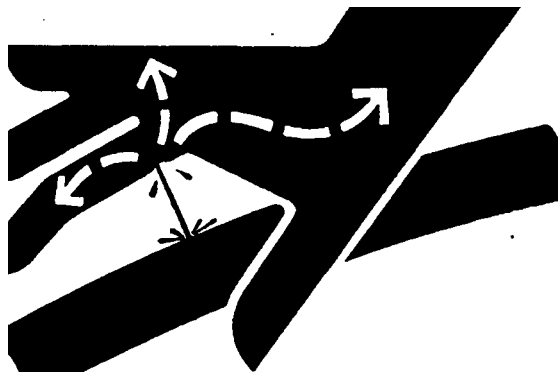

X9811 -UN-23AUG88

DX,FLUID -19-03MAR93-1/1

Park Machine Safely

Before working on the machine:

- Lower all equipment to the ground.
- Stop the engine and remove the key.
- Disconnect the battery ground strap.
- Hang a "DO NOT OPERATE" tag in operator station.

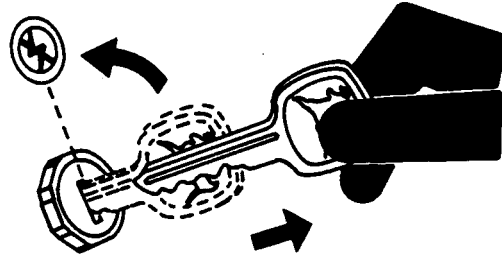

TS230 -UN-24MAY89

DX,PARK -19-04JUN90-1/1

Support Machine Properly

Always lower the attachment or implement to the ground before you work on the machine. If the work requires that the machine or attachment be lifted, provide secure support for them. If left in a raised position, hydraulically supported devices can settle or leak down.

Do not support the machine on cinder blocks, hollow tiles, or props that may crumble under continuous load. Do not work under a machine that is supported solely by a jack. Follow recommended procedures in this manual.

When implements or attachments are used with a machine, always follow safety precautions listed in the implement or attachment operator's manual.

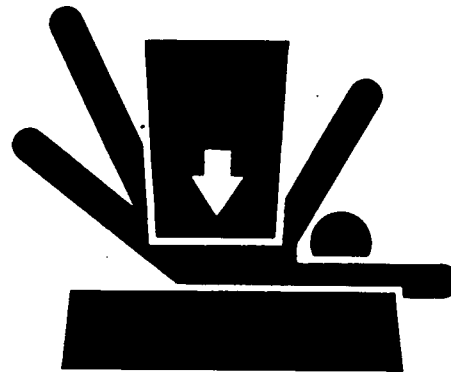

TS229 -UN-23AUG88

DX,LOWER -19-24FEB00-1/1

Wear Protective Clothing

Wear close fitting clothing and safety equipment appropriate to the job.

Operating equipment safely requires the full attention of the operator. Do not wear radio or music headphones while operating machine.

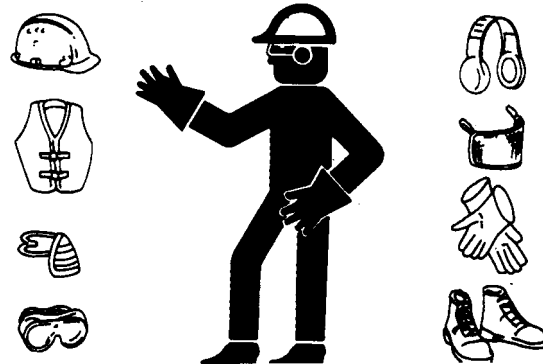

TS206 -UN-23AUG88

DX,WEAR2 -19-03MAR93-1/1

Work in Clean Area

Before starting a job:

- Clean work area and machine.
- Make sure you have all necessary tools to do your job.
- Have the right parts on hand.
- Read all instructions thoroughly; do not attempt shortcuts.

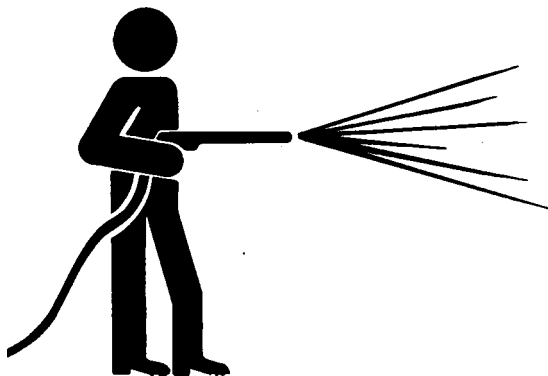

DX,CLEAN -19-04JUN90-1/1

T6642EJ -JUN-18OCT88

Service Machines Safely

Tie long hair behind your head. Do not wear a necktie, scarf, loose clothing, or necklace when you work near machine tools or moving parts. If these items were to get caught, severe injury could result.

Remove rings and other jewelry to prevent electrical shorts and entanglement in moving parts.

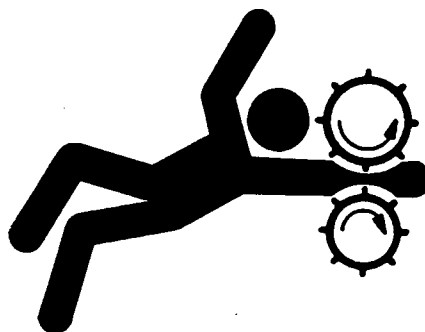

DX,LOOSE -19-04JUN90-1/1

TS228 -JUN-23AUG88

Work In Ventilated Area

Engine exhaust fumes can cause sickness or death. If it is necessary to run an engine in an enclosed area, remove the exhaust fumes from the area with an exhaust pipe extension.

If you do not have an exhaust pipe extension, open the doors and get outside air into the area



DX,AIR -19-17FEB99-1/1

TS220 -JUN-23AUG88

Illuminate Work Area Safely

Illuminate your work area adequately but safely. Use a portable safety light for working inside or under the machine. Make sure the bulb is enclosed by a wire cage. The hot filament of an accidentally broken bulb can ignite spilled fuel or oil.



DX,LIGHT -19-04JUN90-1/1

TS223 -JUN-23AUG88

9000
01
6

Replace Safety Signs

Replace missing or damaged safety signs. See the machine operator's manual for correct safety sign placement.



TS201 -UN-23AUG88

DX,SIGNS1 -19-04JUN90-1/1

Use Proper Lifting Equipment

Lifting heavy components incorrectly can cause severe injury or machine damage.

Follow recommended procedure for removal and installation of components in the manual.

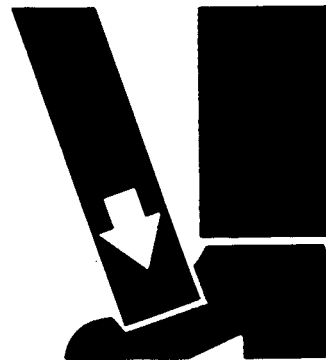

TS226 -UN-23AUG88

DX,LIFT -19-04JUN90-1/1

Remove Paint Before Welding or Heating

Avoid potentially toxic fumes and dust.

Hazardous fumes can be generated when paint is heated by welding, soldering, or using a torch.

Remove paint before heating:

- Remove paint a minimum of 100 mm (4 in.) from area to be affected by heating. If paint cannot be removed, wear an approved respirator before heating or welding.
- If you sand or grind paint, avoid breathing the dust. Wear an approved respirator.
- If you use solvent or paint stripper, remove stripper with soap and water before welding. Remove solvent or paint stripper containers and other flammable material from area. Allow fumes to disperse at least 15 minutes before welding or heating.

Do not use a chlorinated solvent in areas where welding will take place.

Do all work in an area that is well ventilated to carry toxic fumes and dust away.

Dispose of paint and solvent properly.



TS220 -UN-23AUG88

DX,PAINT -19-24JUL02-1/1

Avoid Heating Near Pressurized Fluid Lines

Flammable spray can be generated by heating near pressurized fluid lines, resulting in severe burns to yourself and bystanders. Do not heat by welding, soldering, or using a torch near pressurized fluid lines or other flammable materials. Pressurized lines can accidentally burst when heat goes beyond the immediate flame area.



TS953 -UN-15MAY90

DX,TORCH -19-10DEC04-1/1

Keep ROPS Installed Properly

Make certain all parts are reinstalled correctly if the roll-over protective structure (ROPS) is loosened or removed for any reason. Tighten mounting bolts to proper torque.

The protection offered by ROPS will be impaired if ROPS is subjected to structural damage, is involved in an overturn incident, or is in any way altered by welding, bending, drilling, or cutting. A damaged ROPS should be replaced, not reused.

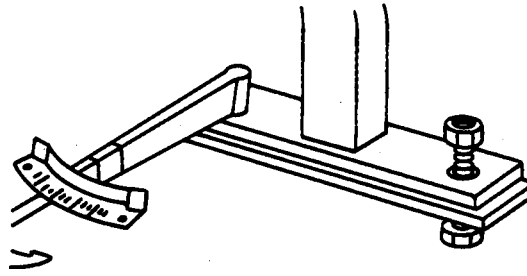

TS212 -UN-23AUG88

DX,ROPS3 -19-03MAR93-1/1

Service Tires Safely

Explosive separation of a tire and rim parts can cause serious injury or death.

Do not attempt to mount a tire unless you have the proper equipment and experience to perform the job.

Always maintain the correct tire pressure. Do not inflate the tires above the recommended pressure. Never weld or heat a wheel and tire assembly. The heat can cause an increase in air pressure resulting in a tire explosion. Welding can structurally weaken or deform the wheel.

When inflating tires, use a clip-on chuck and extension hose long enough to allow you to stand to one side and NOT in front of or over the tire assembly. Use a safety cage if available.

Check wheels for low pressure, cuts, bubbles, damaged rims or missing lug bolts and nuts.

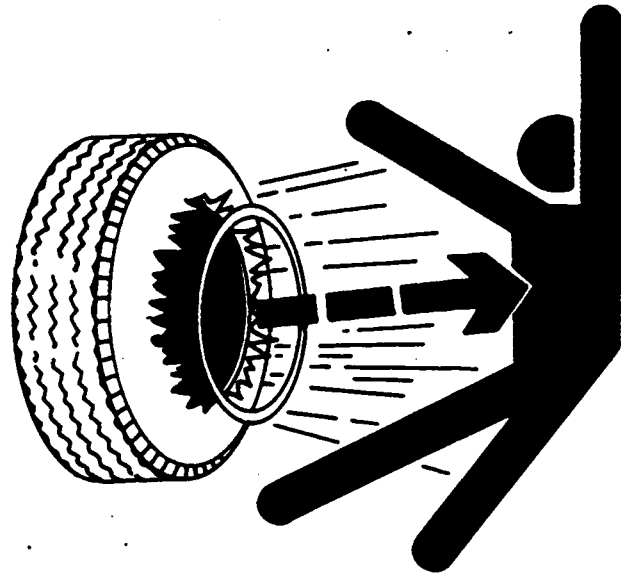

TS211 -UN-23AUG88

DX,RIM -19-24AUG90-1/1

Practice Safe Maintenance

Understand service procedure before doing work. Keep area clean and dry.

Never lubricate, service, or adjust machine while it is moving. Keep hands, feet, and clothing from power-driven parts. Disengage all power and operate controls to relieve pressure. Lower equipment to the ground. Stop the engine. Remove the key. Allow machine to cool.

Securely support any machine elements that must be raised for service work.

Keep all parts in good condition and properly installed. Fix damage immediately. Replace worn or broken parts. Remove any buildup of grease, oil, or debris.

On self-propelled equipment, disconnect battery ground cable (-) before making adjustments on electrical systems or welding on machine.

On towed implements, disconnect wiring harnesses from tractor before servicing electrical system components or welding on machine.



TS218 -JUN-23AUG88

DX,SERV -19-17FEB99-1/1

Use Proper Tools

Use tools appropriate to the work. Makeshift tools and procedures can create safety hazards.

Use power tools only to loosen threaded parts and fasteners.

For loosening and tightening hardware, use the correct size tools. DO NOT use U.S. measurement tools on metric fasteners. Avoid bodily injury caused by slipping wrenches.

Use only service parts meeting John Deere specifications.



TS779 -JUN-08NOV89

DX,REPAIR -19-17FEB99-1/1

9000
01
10

Dispose of Waste Properly

Improperly disposing of waste can threaten the environment and ecology. Potentially harmful waste used with John Deere equipment include such items as oil, fuel, coolant, brake fluid, filters, and batteries.

Use leakproof containers when draining fluids. Do not use food or beverage containers that may mislead someone into drinking from them.

Do not pour waste onto the ground, down a drain, or into any water source.

Air conditioning refrigerants escaping into the air can damage the Earth's atmosphere. Government regulations may require a certified air conditioning service center to recover and recycle used air conditioning refrigerants.

Inquire on the proper way to recycle or dispose of waste from your local environmental or recycling center, or from your John Deere dealer.

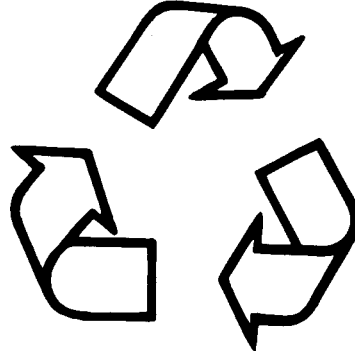

TS1133 -UN-26NOV90

DX,DRAIN -19-03MAR93-1/1

Live With Safety

Before returning machine to customer, make sure machine is functioning properly, especially the safety systems. Install all guards and shields.



TS231 -19-07OCT88

DX,LIVE -19-25SEP92-1/1

310SE and 315SE Specifications

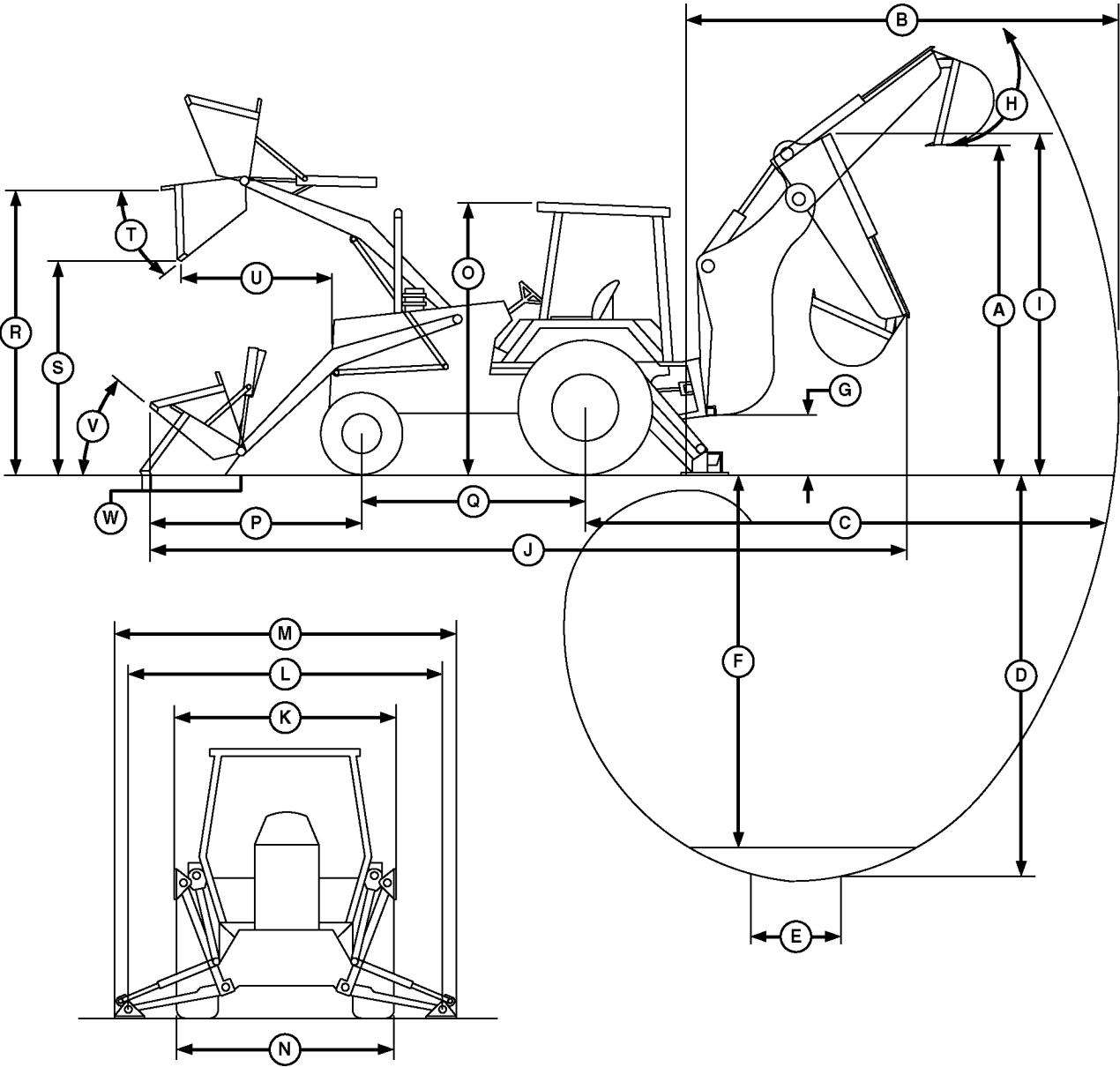

T103503

T103503 -JUN-10SEP96

TX,110,BD2218 -19-08OCT96-1/1

9000
02
2

**310SE and 315SE Backhoe Loader
Dimensions**

NOTE: Specifications and design subject to change without notice. Whenever applicable, specifications are in accordance with SAE Standards unless otherwise noted, these specifications are based on a standard machine with 19.5L-24, 8PR, R4 rear tires; 11L-16, 12PR, F3 front tires; 0.86 m³ (1.12 cu yd) loader bucket; 610 mm (24 in.) backhoe bucket; ROPS/FOPS; full fuel tank and 79 kg (175 lb) operator.

Item	Measurement	Specification
A—Loading Height, Truck Loading Position		
Backhoe w/o Ext. Dipperstick	Height	3.43 m (11 ft 3 in.)
Backhoe w/Ext. Dipperstick Retracted	Height	3.53 m (11 ft 7 in.)
Backhoe w/Ext. Dipperstick Extended	Height	4.29 m (14 ft 1 in.)
B—Reach from Center of Swing Mast		
Backhoe w/o Ext. Dipperstick	Distance	5.56 m (18 ft 3 in.)
Backhoe w/Ext. Dipperstick Retracted	Distance	5.66 m (18 ft 7 in.)
Backhoe w/Ext. Dipperstick Extended	Distance	6.68 m (21 ft 11 in.)
C—Reach from Center of Rear Axle		
Backhoe w/o Ext. Dipperstick	Distance	6.63 m (21 ft 9 in.)
Backhoe w/Ext. Dipperstick Retracted	Distance	6.73 m (22 ft 1 in.)
Backhoe w/Ext. Dipperstick Extended	Distance	7.72 m (25 ft 4 in.)

Continued on next page

CED,OUO1040,162 -19-10JUN98-1/7

General Specifications

9000
02
3

Item	Measurement	Specification
D—Maximum Digging Depth		
Backhoe w/o Ext. Dipperstick	Depth	4.42 m (14 ft 6 in.)
Backhoe w/Ext. Dipperstick Retracted	Depth	4.55 m (14 ft 11 in.)
Backhoe w/Ext. Dipperstick Extended	Depth	5.61 m (18 ft 5 in.)
E—Digging Depth (SAE)—(1) 10 mm (2 ft) Flat Bottom		
Backhoe w/o Ext. Dipperstick	Distance	4.37 m (14 ft 4 in.)
Backhoe w/Ext. Dipperstick Retracted	Distance	4.50 m (14 ft 9 in.)
Backhoe w/Ext. Dipperstick Extended	Distance	5.56 m (18 ft 3 in.)
F—Digging Depth (SAE)—(2) 2440 mm (8 ft) Flat Bottom		
Backhoe w/o Ext. Dipperstick	Distance	4.06 m (13 ft 4 in.)
Backhoe w/Ext. Dipperstick Retracted	Distance	4.19 m (13 ft 9 in.)
Backhoe w/Ext. Dipperstick Extended	Distance	5.33 m (17 ft 6 in.)
G—Ground Clearance Minimum		
Backhoe w/o Ext. Dipperstick	Clearance	330 mm (13 in.)
Backhoe w/Ext. Dipperstick Retracted	Clearance	330 mm (13 in.)
Backhoe w/Ext. Dipperstick Extended	Clearance	330 mm (13 in.)

Continued on next page

CED.OUO1040,162 -19-10JUN98-2/7

General Specifications

9000
02
4

Item	Measurement	Specification
H—Bucket Rotation		
Backhoe w/o Ext. Dipperstick	Rotation	190°
Backhoe w/Ext. Dipperstick Retracted	Rotation	190°
Backhoe w/Ext. Dipperstick Extended	Rotation	190°
I—Transport Height		
Backhoe w/o Ext. Dipperstick	Height	3.51 m (11 ft 6 in.)
Backhoe w/Ext. Dipperstick Retracted	Height	3.48 m (11 ft 5 in.)
J—Overall Length, Transport		
Backhoe	Length	7.16 m (23 ft 6 in.)
K—Stabilizer Width, Transport		
Backhoe	Width	2.18 m (7 ft 2 in.)
L—Stabilizer Spread, Operating		
Backhoe	Width	3.10 m (10 ft 2 in.)
M—Overall Width, Stabilizer Spread (Less Loader Bucket)—310SE		
Backhoe	Width	3.53 m (11 ft 7 in.)
M—Overall Width, Stabilizer Spread—315SE		
Backhoe	Width	2.24 m (7 ft 6 in.)

Continued on next page

CED,OUO1040,162 -19-10JUN98-3/7

General Specifications

9000
02
5

Item	Measurement	Specification
N—Width Over Tires		
Backhoe	Width	2.18 m (7 ft 2 in.)
O—Height to Cab/ROPS Top		
Backhoe	Height	2.79 m (9 ft 2 in.)
P—Front Wheel to Loader Dig Position		
Backhoe	Distance	1.12 m (3 ft 8 in.)
Q—Wheelbase		
Backhoe	Length	2.10 m (6 ft 10 in.)
R—Maximum Height to Loader Bucket Hinge Pin		
Heavy Duty Long Lip 0.86 m ³ (1.12 yd ³)	Height	3.4 m (11 ft 2 in.)
Heavy Duty Long Lip 1.0 m ³ (1.30 yd ³)	Height	3.4 m (11 ft 2 in.)
Multipurpose 0.76 m ³ (1.00 yd ³)	Height	3.4 m (11 ft 2 in.)
S—Dump Clearance, Loader Bucket at 45°		
Heavy Duty Long Lip 0.86 m ³ (1.12 yd ³)	Clearance	2.69 m (8 ft 10 in.)
Heavy Duty Long Lip 1.0 m ³ (1.30 yd ³)	Clearance	2.64 m (8 ft 8 in.)
Multipurpose 0.76 m ³ (1.00 yd ³)	Clearance	2.62 m (8 ft 7 in.)

Continued on next page

CED.OUO1040.162 -19-10JUN98-4/7

General Specifications

9000
02
6

Item	Measurement	Specification
T—Maximum Loader Bucket Dump Angle		
Heavy Duty Long Lip 0.86 m ³ (1.12 yd ³)	Angle	45°
Heavy Duty Long Lip 1.0 m ³ (1.30 yd ³)	Angle	45°
Multipurpose 0.76 m ³ (1.00 yd ³)	Angle	45°
U—Reach at Full Height, Loader Bucket at 45°		
Heavy Duty Long Lip 0.86 m ³ (1.12 yd ³)	Distance	767 mm (30.2 in.)
Heavy Duty Long Lip 1.0 m ³ (1.30 yd ³)	Distance	765 mm (30.1 in.)
Multipurpose 0.76 m ³ (1.00 yd ³)	Distance	818 mm (32.2 in.)
V—Loader Bucket Rollback at Ground Level		
Heavy Duty Long Lip 0.86 m ³ (1.12 yd ³)	Angle	40°
Heavy Duty Long Lip 1.0 m ³ (1.30 yd ³)	Angle	40°
Multipurpose 0.76 m ³ (1.00 yd ³)	Angle	40°
W—Dig Below Ground—Loader Bucket Level		
Heavy Duty Long Lip 0.86 m ³ (1.12 yd ³)	Depth	163 mm (6.4 in.)
Heavy Duty Long Lip 1.0 m ³ (1.30 yd ³)	Depth	206 mm (8.1 in.)
Multipurpose 0.76 m ³ (1.00 yd ³)	Depth	185 mm (7.3 in.)

Continued on next page

CED,OUO1040,162 -19-10JUN98-5/7

General Specifications

9000
02
7

Item	Measurement	Specification
Digging Force, Bucket Cylinder		
Backhoe w/o Ext. Dipperstick	Force	53.3 kN (11,990 lb)
Backhoe w/Ext. Dipperstick Retracted	Force	54.1 kN (12,158 lb)
Backhoe w/Ext. Dipperstick Extended	Force	54.1 kN (12,158 lb)
Digging Force, Crowd Cylinder		
Backhoe w/o Ext. Dipperstick	Force	36.0 kN (8090 lb)
Backhoe w/Ext. Dipperstick Retracted	Force	34.7 kN (7796 lb)
Backhoe w/Ext. Dipperstick Extended	Force	25.0 kN (5628 lb)
Swing Arc		
Backhoe w/o Ext. Dipperstick	Rotation	180°
Backhoe w/Ext. Dipperstick Retracted	Rotation	180°
Backhoe w/Ext. Dipperstick Extended	Rotation	180°
Bucket Rotation		
Backhoe w/o Ext. Dipperstick	Rotation	190°
Backhoe w/Ext. Dipperstick Retracted	Rotation	190°
Backhoe w/Ext. Dipperstick Extended	Rotation	190°
Stabilizer Angle Rearward		
Backhoe w/o Ext. Dipperstick	Angle	18°

Continued on next page

CED,OUO1040,162 -19-10JUN98-6/7

General Specifications

9000
02
8

Item	Measurement	Specification
Backhoe w/Ext. Dipperstick Retracted	Angle	18°
Backhoe w/Ext. Dipperstick Extended	Angle	18°

CED,OUO1040,162 -19-10JUN98-7/7

310SE and 315SE Backhoe Loader—Specifications

NOTE: Specifications and design subject to change without notice. Wherever applicable,

specifications are in accordance with Standards.

Item	Measurement	Specification
Engine—John Deere 4045T		
Rated Power @ 2200 rpm	Power	SAE gross 66 kW (88 hp)
Rated Power @ 2200 rpm	Power	SAE net 60 kW (80 hp)
Cylinders	Quantity	4
Displacement	Volume	4.52 L (276 in. ³)
Engine Torque Rise	Torque	42%
Maximum Engine Net Torque	Torque	368 N•m (271 lb-ft)
Electrical System	Voltage	12-volt
Alternator	Amperage	65 amps
Alternator with Cab	Amperage	95 amps

Item	Measurement	Specification
310SE Forward Travel Speeds ¹ with Manual Transmission		
Gear 1	Speed	5.8 km/h (3.6 mph)
Gear 2	Speed	9.5 km/h (5.9 mph)
Gear 3	Speed	23.2 km/h (14.4 mph)
Gear 4	Speed	39.3 km/h (24.4 mph)
310SE Reverse Travel Speeds ¹ with Manual Transmission		
Gear 1	Speed	6.4 km/h (4.0 mph)

¹With standard 19.5L-24 rear tires.

General Specifications

9000
02
10

Item	Measurement	Specification
Gear 2	Speed	10.6 km/h (6.6 mph)
Gear 3	Speed	25.9 km/h (16.1 mph)
Gear 4	Speed	43.8 km/h (27.2 mph)
310SE Forward Travel Speeds¹ with Powershift Transmission		
Gear 1	Speed	5.8 km/h (3.6 mph)
Gear 2	Speed	9.5 km/h (5.9 mph)
Gear 3	Speed	23.2 km/h (14.4 mph)
Gear 4	Speed	39.3 km/h (24.4 mph)
310SE Reverse Travel Speeds¹ with Powershift Transmission		
Gear 1	Speed	6.4 km/h (4.0 mph)
Gear 2	Speed	10.6 km/h (6.6 mph)
Gear 3	Speed	25.9 km/h (16.1 mph)
Gear 4	Speed	43.8 km/h (27.2 mph)
315SE Forward Travel Speeds¹ with Manual Transmission		
Gear 1	Speed	6.1 km/h (3.8 mph)
Gear 2	Speed	10.1 km/h (6.3 mph)
Gear 3	Speed	24.6 km/h (15.3 mph)
Gear 4	Speed	41.5 km/h (25.8 mph)

¹With standard 19.5L-24 rear tires.

Continued on next page

TX,115,BG321 -19-10JUN98-2/4

General Specifications

9000
02
11

Item	Measurement	Specification
315SE Reverse Travel Speeds¹ with Manual Transmission		
Gear 1	Speed	6.8 km/h (4.2 mph)
Gear 2	Speed	11.3 km/h (7.0 mph)
Gear 3	Speed	27.4 km/h (17.1 mph)
Gear 4	Speed	46.3 km/h (28.8 mph)
315SE Forward Travel Speeds¹ with Powershift Transmission		
Gear 1	Speed	6.1 km/h (3.8 mph)
Gear 2	Speed	10.1 km/h (6.3 mph)
Gear 3	Speed	24.6 km/h (15.3 mph)
Gear 4	Speed	41.5 km/h (25.8 mph)
315SE Reverse Travel Speeds¹ with Powershift Transmission		
Gear 1	Speed	6.8 km/h (4.2 mph)
Gear 2	Speed	11.3 km/h (7.0 mph)
Gear 3	Speed	27.4 km/h (17.1 mph)
Gear 4	Speed	46.3 km/h (28.8 mph)

NOTE: With powershift transmission, third and fourth gear speeds are the same in reverse.

Item	Measurement	Specification
Steering: Hydrostatic Power		
Non-Powered Axle Curb Turning Radius—Brakes Applied	Radius	3.57 m (11 ft 9 in.)

¹With standard 19.5L-24 rear tires.

General Specifications

9000
02
12

Item	Measurement	Specification
Non-Powered Axle Curb Turning Radius—Without Brakes	Radius	4.04 m (13 ft 3 in.)
Non-Powered Axle Bucket Clearance Circle—Brakes Applied	Radius	9.07 m (29 ft 9 in.)
Non-Powered Axle Bucket Clearance Circle—Without Brakes	Radius	10.74 m (35 ft 3 in.)
Non-Powered Axle Steering Wheel Turns—Stop to Stop	Quantity	2.3—3.0 turns
Powered Axle (MFWD) Curb Turning Radius—Brakes Applied	Radius	3.34 m (10 ft 11 in.)
Powered Axle (MFWD) Curb Turning Radius—Without Brakes	Radius	4.17 m (13 ft 8 in.)
Powered Axle Bucket Clearance Circle—Brakes Applied	Radius	9.07 m (29 ft 9 in.)
Powered Axle Bucket Clearance Circle—Without Brakes	Radius	10.74 m (35 ft 3 in.)
Powered Axle Steering Wheel Turns—Stop to Stop	Quantity	2.5 turns

Item	Measurement	Specification
Hydraulic System: Open Center		
Pressure Relief Setting—Backhoe	Pressure	25 000 kPa (3625 psi)
Pressure Relief Setting—Loader	Pressure	19 000 kPa (2750 psi)
Flow @ 2200 rpm, Backhoe	Flow Rate	136 L/min. (36 gpm)
Flow @ 2200 rpm, Loader	Flow Rate	106 L/min. (28 gpm)

TX,115,BG321 -19-10JUN98-4/4

