

300D, 310D, 315D Backhoe Loader Operation and Test

TECHNICAL MANUAL
TM1496 21SEP05 (ENGLISH)

For complete service information also see:

300D, 310D, 315D Backhoe Loaders
Repair (Complete)..... TM1497
300D, 310D, 315D Backhoe Loaders
Operation and Test (Complete)..... TM1496



**Worldwide Construction
And Forestry Division**
LITHO IN U.S.A.

Introduction

Foreword

This manual is written for an experienced technician. Essential tools required in performing certain service work are identified in this manual and are recommended for use.

Live with safety: Read the safety messages in the introduction of this manual and the cautions presented throughout the text of the manual.

 This is the safety-alert symbol. When you see this symbol on the machine or in this manual, be alert to the potential for personal injury.

Technical manuals are divided in two parts: repair and operation and tests. Repair sections tell how to repair the components. Operation and tests sections help you identify the majority of routine failures quickly.

Information is organized in groups for the various components requiring service instruction. At the beginning of each group are summary listings of all applicable essential tools, service equipment and tools, other materials needed to do the job, service parts kits, specifications, wear tolerances, and torque values.

Technical Manuals are concise guides for specific machines. They are on-the-job guides containing only the vital information needed for diagnosis, analysis, testing, and repair.

Fundamental service information is available from other sources covering basic theory of operation, fundamentals of troubleshooting, general maintenance, and basic type of failures and their causes.

See DB1990 Service Publications Catalog to order a complete Technical Manual (TM) or a Technical Manual Section (TMS). A complete Operation and Test manual includes the following sections:

- TMS14969000
Section 9000 General Information
- TMS14969005

Section 9005 Operational Checkout Procedure

Section 9010 Engine

- TMS14969015

Section 9015 Electrical System

- TMS14969020

Section 9020 Power Train

- TMS14969025

Section 9025 Hydraulics

- TMS14969031

Section 9031 Heating and Air Conditioning

TX,1496,RR4512 -19-20JUN94-1/1



Contents

SECTION 9000—General Information

- Group 01—Safety Information
- Group 02—General Specifications
- Group 03—Torque Values
- Group 04—Fuels And Lubricants

SECTION 9005—Operational Checkout Procedure

- Group 10—Operational Checkout Procedure

SECTION 9010—Engine

- Group 05—Theory Of Operation
- Group 10—System Operational Checks
- Group 15—System Diagnostic Information
- Group 20—Adjustments
- Group 25—Tests

SECTION 9015—Electrical System

- Group 05—System Information
- Group 10—System Diagrams
- Group 15—Sub-System Diagnostics
- Group 20—References

SECTION 9020—Power Train

- Group 05—Theory Of Operation
- Group 10—System Operational Checks
- Group 15—System Diagnostic Information
- Group 20—Adjustments
- Group 25—Tests

SECTION 9025—Hydraulics

- Group 05—Theory Of Operation
- Group 10—System Operational Checks
- Group 15—Diagnostic Information
- Group 20—Adjustments
- Group 25—Tests

SECTION 9031—Heating And Air Conditioning

- Group 05—Theory Of Operation
- Group 10—System Operational Checks
- Group 15—Diagnostic Information
- Group 20—Adjustments
- Group 25—Test

All information, illustrations and specifications in this manual are based on the latest information available at the time of publication. The right is reserved to make changes at any time without notice.

COPYRIGHT © 1994
DEERE & COMPANY
Moline, Illinois
All rights reserved
A John Deere ILLUSTRATION® Manual
Previous Editions
Copyright © 1993,1990

9000

9005

9010

9015

9020

9025

9031

INDX

Contents

9000

9005

9010

9015

9020

9025

9031

INDX

Section 9000

General Information

Contents

Page	Page
Group 01—Safety Information	
Handle Fluids Safely—Avoid Fires	9000-01-1
Prevent Battery Explosions	9000-01-1
Prepare for Emergencies.	9000-01-1
Prevent Acid Burns	9000-01-2
Handle Chemical Products Safely.....	9000-01-3
Avoid High-Pressure Fluids	9000-01-3
Park Machine Safely	9000-01-4
Support Machine Properly	9000-01-4
Wear Protective Clothing.	9000-01-4
Work in Clean Area.	9000-01-5
Service Machines Safely	9000-01-5
Work In Ventilated Area	9000-01-5
Illuminate Work Area Safely	9000-01-5
Replace Safety Signs	9000-01-6
Use Proper Lifting Equipment	9000-01-6
Remove Paint Before Welding or Heating . .	9000-01-6
Avoid Heating Near Pressurized Fluid Lines	9000-01-7
Keep ROPS Installed Properly	9000-01-7
Service Tires Safely	9000-01-8
Avoid Harmful Asbestos Dust	9000-01-8
Practice Safe Maintenance	9000-01-9
Use Proper Tools	9000-01-9
Dispose of Waste Properly	9000-01-10
Live With Safety	9000-01-10
Group 02—General Specifications	
300D Specifications.	9000-02-1
300D Backhoe Loader.	9000-02-2
300D Backhoe Loader (Continued)	9000-02-3
300D Backhoe Loader Buckets	9000-02-4
300D Backhoe Loader Drain And Refill Capacities	9000-02-5
300D Backhoe Loader Lifting Capacities— KG (LB)	9000-02-6
310D Specifications.	9000-02-9
310D Backhoe Loader.	9000-02-10
310D Backhoe Loader (Continued)	9000-02-11
310D Buckets	9000-02-13
310D Drain And Refill Capacities	9000-02-14
310D Backhoe Loader Lifting Capacities— KG (LB)	9000-02-14
315D Specifications	9000-02-17
315D Sideshift Backhoe Loader	9000-02-18
315D Sideshift Backhoe Loader (Continued).....	9000-02-19
315D Buckets.....	9000-02-20
315D Sideshift Backhoe Loader Drain And Refill Capacities.....	9000-02-20
315D Lift Capacity—LB (KG).....	9000-02-21
Group 03—Torque Values	
Hardware Torque Specifications	9000-03-1
Checking Wheel Fasteners.....	9000-03-1
Unified Inch Bolt and Cap Screw Torque Values	9000-03-2
Additional Metric Cap Screw Torque Values	9000-03-3
Check Oil Lines And Fittings	9000-03-5
Service Recommendations for 37° Flare and 30° Cone Seat Connectors	9000-03-6
Service Recommendations for O-Ring Boss Fittings.....	9000-03-7
Service Recommendations for Flat Face O-Ring Seal Fittings	9000-03-9
Service Recommendations For Inch Series Four Bolt Flange Fittings	9000-03-10
Service Recommendations for Metric Series Four Bolt Flange Fitting	9000-03-11
Group 04—Fuels And Lubricants	
Fuel Specifications.....	9000-04-1
Low Sulfur Diesel Fuel Conditioner	9000-04-1
Storing Fuel.....	9000-04-2
Do Not Use Galvanized Containers.....	9000-04-2
Fuel Tank	9000-04-2
Engine Oil	9000-04-3
Transaxle Oil.....	9000-04-4
Hydraulic And Reverser Oil	9000-04-5
Mechanical Front Wheel Drive Oil	9000-04-6
Grease	9000-04-7
Grease For Extendible Dipperstick	9000-04-7
Alternative and Synthetic Lubricants	9000-04-8
Lubricant Storage.....	9000-04-8
Mixing of Lubricants.....	9000-04-9
Diesel Engine Coolant	9000-04-9

Contents

9000

Handle Fluids Safely—Avoid Fires

When you work around fuel, do not smoke or work near heaters or other fire hazards.

Store flammable fluids away from fire hazards. Do not incinerate or puncture pressurized containers.

Make sure machine is clean of trash, grease, and debris.

Do not store oily rags; they can ignite and burn spontaneously.



TS227 -UN-23AUG88

DX,FLAME -19-29SEP98-1/1

Prevent Battery Explosions

Keep sparks, lighted matches, and open flame away from the top of battery. Battery gas can explode.

Never check battery charge by placing a metal object across the posts. Use a volt-meter or hydrometer.

Do not charge a frozen battery; it may explode. Warm battery to 16°C (60°F).



TS204 -UN-23AUG88

DX,SPARKS -19-03MAR93-1/1

Prepare for Emergencies

Be prepared if a fire starts.

Keep a first aid kit and fire extinguisher handy.

Keep emergency numbers for doctors, ambulance service, hospital, and fire department near your telephone.

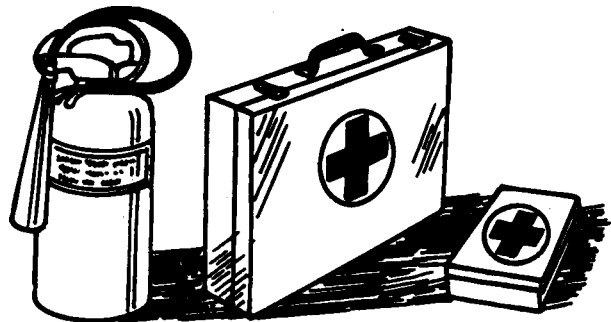

TS291 -UN-23AUG88

DX,FIRE2 -19-03MAR93-1/1

9000
01
2

Prevent Acid Burns

Sulfuric acid in battery electrolyte is poisonous. It is strong enough to burn skin, eat holes in clothing, and cause blindness if splashed into eyes.

Avoid the hazard by:

1. Filling batteries in a well-ventilated area.
2. Wearing eye protection and rubber gloves.
3. Avoiding breathing fumes when electrolyte is added.
4. Avoiding spilling or dripping electrolyte.
5. Use proper jump start procedure.

If you spill acid on yourself:

1. Flush your skin with water.
2. Apply baking soda or lime to help neutralize the acid.
3. Flush your eyes with water for 15—30 minutes. Get medical attention immediately.

If acid is swallowed:

1. Do not induce vomiting.
2. Drink large amounts of water or milk, but do not exceed 2 L (2 quarts).
3. Get medical attention immediately.

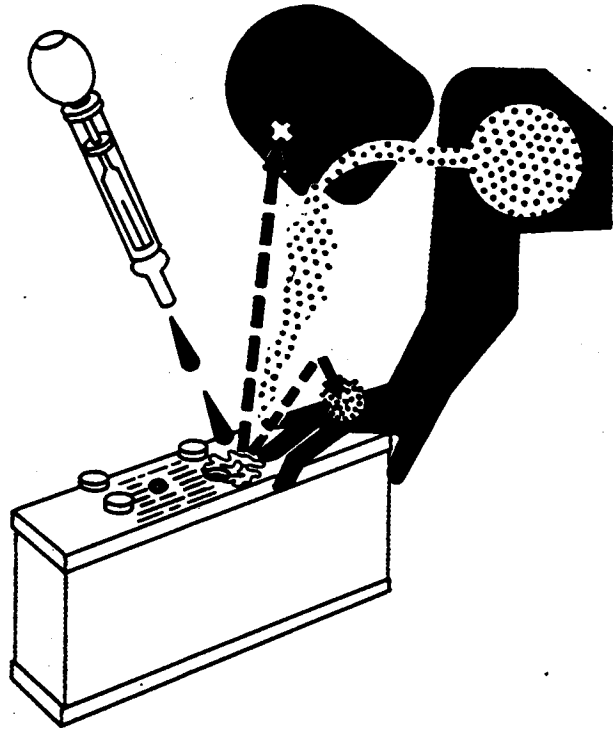

TS203 -JUN-23AUG88

DX,POISON -19-21APR93-1/1

Handle Chemical Products Safely

Direct exposure to hazardous chemicals can cause serious injury. Potentially hazardous chemicals used with John Deere equipment include such items as lubricants, coolants, paints, and adhesives.

A Material Safety Data Sheet (MSDS) provides specific details on chemical products: physical and health hazards, safety procedures, and emergency response techniques.

Check the MSDS before you start any job using a hazardous chemical. That way you will know exactly what the risks are and how to do the job safely. Then follow procedures and recommended equipment.

(See your John Deere dealer for MSDS's on chemical products used with John Deere equipment.)



TS1132 -UN-26NOV90

DX,MSDS,NA -19-03MAR93-1/1

Avoid High-Pressure Fluids

Escaping fluid under pressure can penetrate the skin causing serious injury.

Avoid the hazard by relieving pressure before disconnecting hydraulic or other lines. Tighten all connections before applying pressure.

Search for leaks with a piece of cardboard. Protect hands and body from high pressure fluids.

If an accident occurs, see a doctor immediately. Any fluid injected into the skin must be surgically removed within a few hours or gangrene may result. Doctors unfamiliar with this type of injury should reference a knowledgeable medical source. Such information is available from Deere & Company Medical Department in Moline, Illinois, U.S.A.

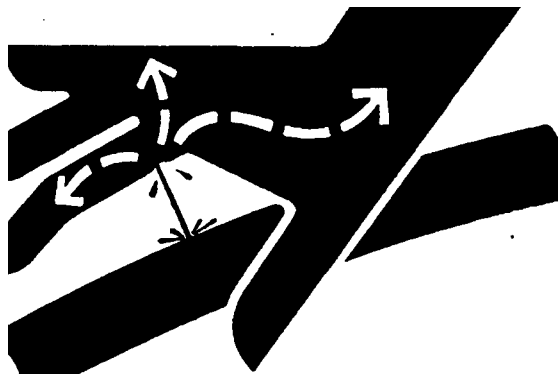

X9811 -UN-23AUG88

DX,FLUID -19-03MAR93-1/1

9000
01
4

Park Machine Safely

Before working on the machine:

- Lower all equipment to the ground.
- Stop the engine and remove the key.
- Disconnect the battery ground strap.
- Hang a "DO NOT OPERATE" tag in operator station.

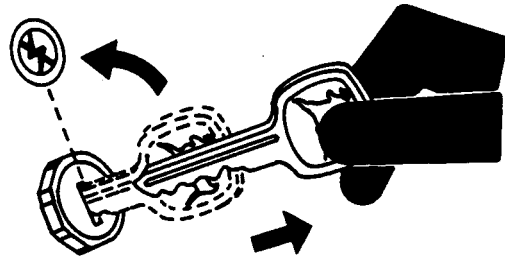

TS230 -UN-24MAY89

DX,PARK -19-04JUN90-1/1

Support Machine Properly

Always lower the attachment or implement to the ground before you work on the machine. If you must work on a lifted machine or attachment, securely support the machine or attachment. If left in a raised position, hydraulically supported devices can settle or leak down.

Do not support the machine on cinder blocks, hollow tiles, or props that may crumble under continuous load. Do not work under a machine that is supported solely by a jack. Follow recommended procedures in this manual.

When implements or attachments are used with a tractor, always follow safety precautions listed in the implement operator's manual.

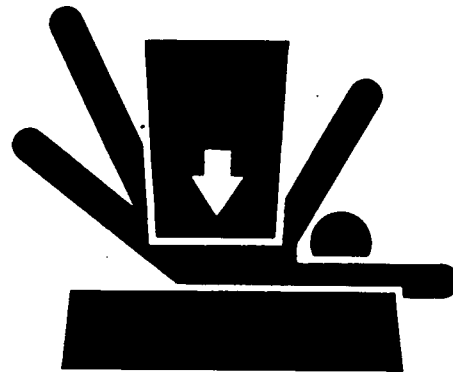

TS229 -UN-23AUG88

DX,LOWER -19-17FEB99-1/1

Wear Protective Clothing

Wear close fitting clothing and safety equipment appropriate to the job.

Operating equipment safely requires the full attention of the operator. Do not wear radio or music headphones while operating machine.

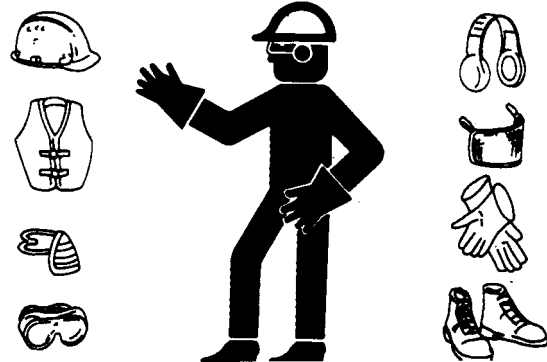

TS206 -UN-23AUG88

DX,WEAR2 -19-03MAR93-1/1

Work in Clean Area

Before starting a job:

- Clean work area and machine.
- Make sure you have all necessary tools to do your job.
- Have the right parts on hand.
- Read all instructions thoroughly; do not attempt shortcuts.

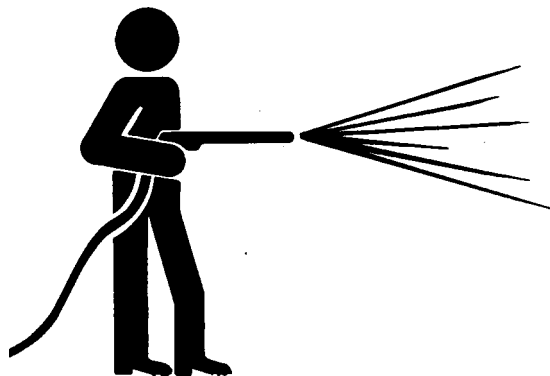

DX,CLEAN -19-04JUN90-1/1

T6642EJ -JUN-18OCT88

Service Machines Safely

Tie long hair behind your head. Do not wear a necktie, scarf, loose clothing, or necklace when you work near machine tools or moving parts. If these items were to get caught, severe injury could result.

Remove rings and other jewelry to prevent electrical shorts and entanglement in moving parts.

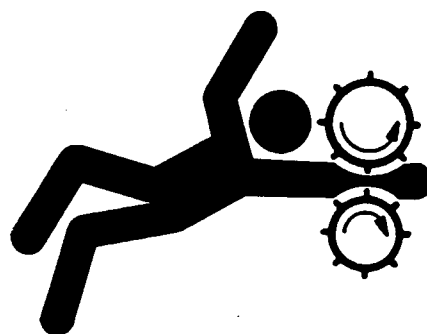

DX,LOOSE -19-04JUN90-1/1

TS228 -JUN-23AUG88

Work In Ventilated Area

Engine exhaust fumes can cause sickness or death. If it is necessary to run an engine in an enclosed area, remove the exhaust fumes from the area with an exhaust pipe extension.

If you do not have an exhaust pipe extension, open the doors and get outside air into the area



DX,AIR -19-17FEB99-1/1

TS220 -JUN-23AUG88

Illuminate Work Area Safely

Illuminate your work area adequately but safely. Use a portable safety light for working inside or under the machine. Make sure the bulb is enclosed by a wire cage. The hot filament of an accidentally broken bulb can ignite spilled fuel or oil.



DX,LIGHT -19-04JUN90-1/1

TS223 -JUN-23AUG88

9000
01
6

Replace Safety Signs

Replace missing or damaged safety signs. See the machine operator's manual for correct safety sign placement.



DX,SIGNS1 -19-04JUN90-1/1

TS201 -UN-23AUG88

Use Proper Lifting Equipment

Lifting heavy components incorrectly can cause severe injury or machine damage.

Follow recommended procedure for removal and installation of components in the manual.

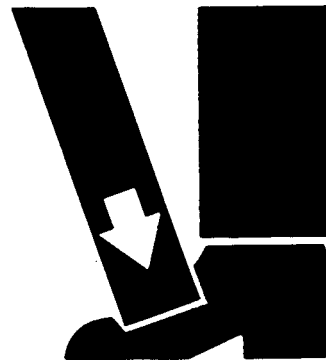

DX,LIFT -19-04JUN90-1/1

TS226 -UN-23AUG88

Remove Paint Before Welding or Heating

Avoid potentially toxic fumes and dust.

Hazardous fumes can be generated when paint is heated by welding, soldering, or using a torch.

Do all work outside or in a well ventilated area. Dispose of paint and solvent properly.

Remove paint before welding or heating:

- If you sand or grind paint, avoid breathing the dust. Wear an approved respirator.
- If you use solvent or paint stripper, remove stripper with soap and water before welding. Remove solvent or paint stripper containers and other flammable material from area. Allow fumes to disperse at least 15 minutes before welding or heating.

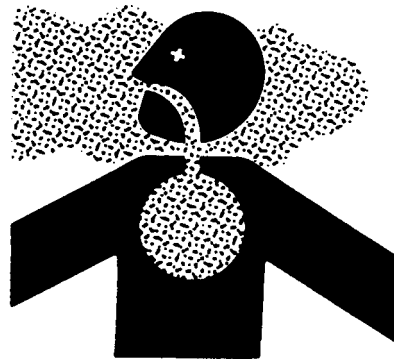

DX,PAINT -19-03MAR93-1/1

TS220 -UN-23AUG88

Avoid Heating Near Pressurized Fluid Lines

Flammable spray can be generated by heating near pressurized fluid lines, resulting in severe burns to yourself and bystanders. Do not heat by welding, soldering, or using a torch near pressurized fluid lines or other flammable materials. Pressurized lines can be accidentally cut when heat goes beyond the immediate flame area.



TS953 -UN-15MAY90

DX,TORCH -19-03MAR93-1/1

Keep ROPS Installed Properly

Make certain all parts are reinstalled correctly if the roll-over protective structure (ROPS) is loosened or removed for any reason. Tighten mounting bolts to proper torque.

The protection offered by ROPS will be impaired if ROPS is subjected to structural damage, is involved in an overturn incident, or is in any way altered by welding, bending, drilling, or cutting. A damaged ROPS should be replaced, not reused.

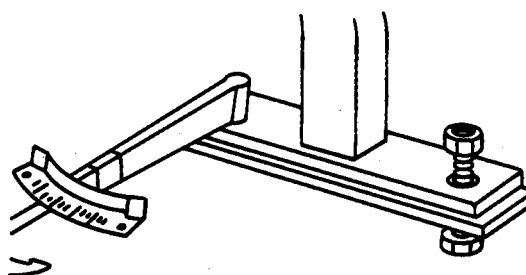

TS212 -UN-23AUG88

DX,ROPS3 -19-03MAR93-1/1

Service Tires Safely

Explosive separation of a tire and rim parts can cause serious injury or death.

Do not attempt to mount a tire unless you have the proper equipment and experience to perform the job.

Always maintain the correct tire pressure. Do not inflate the tires above the recommended pressure. Never weld or heat a wheel and tire assembly. The heat can cause an increase in air pressure resulting in a tire explosion. Welding can structurally weaken or deform the wheel.

When inflating tires, use a clip-on chuck and extension hose long enough to allow you to stand to one side and NOT in front of or over the tire assembly. Use a safety cage if available.

Check wheels for low pressure, cuts, bubbles, damaged rims or missing lug bolts and nuts.

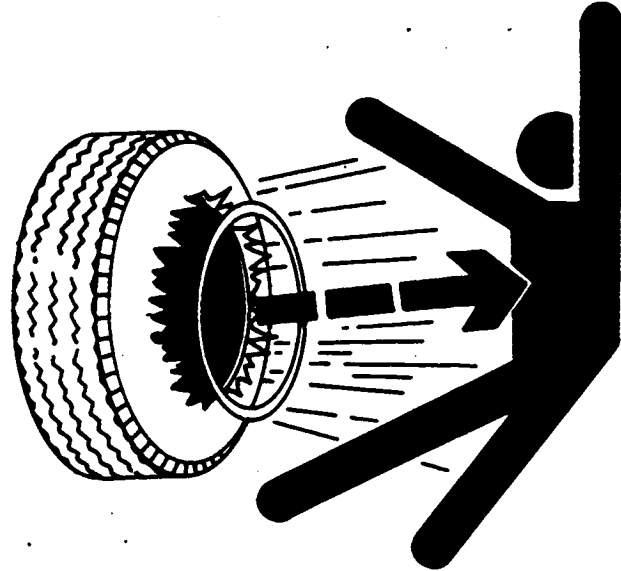

TS211 -UN-23AUG88

DX,RIM -19-24AUG90-1/1

Avoid Harmful Asbestos Dust

Avoid breathing dust that may be generated when handling components containing asbestos fibers. Inhaled asbestos fibers may cause lung cancer.

Components in products that may contain asbestos fibers are brake pads, brake band and lining assemblies, clutch plates, and some gaskets. The asbestos used in these components is usually found in a resin or sealed in some way. Normal handling is not hazardous as long as airborne dust containing asbestos is not generated.

Avoid creating dust. Never use compressed air for cleaning. Avoid brushing or grinding material containing asbestos. When servicing, wear an approved respirator. A special vacuum cleaner is recommended to clean asbestos. If not available, apply a mist of oil or water on the material containing asbestos.

Keep bystanders away from the area.

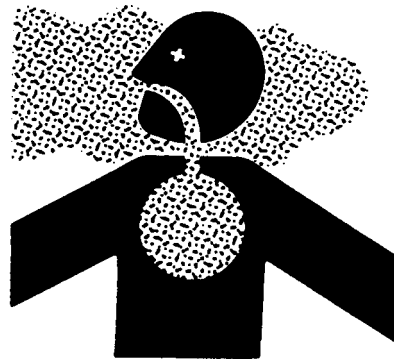

TS220 -UN-23AUG88

DX,DUST -19-15MAR91-1/1

Practice Safe Maintenance

Understand service procedure before doing work. Keep area clean and dry.

Never lubricate, service, or adjust machine while it is moving. Keep hands, feet, and clothing from power-driven parts. Disengage all power and operate controls to relieve pressure. Lower equipment to the ground. Stop the engine. Remove the key. Allow machine to cool.

Securely support any machine elements that must be raised for service work.

Keep all parts in good condition and properly installed. Fix damage immediately. Replace worn or broken parts. Remove any buildup of grease, oil, or debris.

On self-propelled equipment, disconnect battery ground cable (-) before making adjustments on electrical systems or welding on machine.

On towed implements, disconnect wiring harnesses from tractor before servicing electrical system components or welding on machine.



TS218 -JUN-23AUG88

DX,SERV -19-17FEB99-1/1

Use Proper Tools

Use tools appropriate to the work. Makeshift tools and procedures can create safety hazards.

Use power tools only to loosen threaded parts and fasteners.

For loosening and tightening hardware, use the correct size tools. DO NOT use U.S. measurement tools on metric fasteners. Avoid bodily injury caused by slipping wrenches.

Use only service parts meeting John Deere specifications.



TS779 -JUN-08NOV89

DX,REPAIR -19-17FEB99-1/1

9000
01
10

Dispose of Waste Properly

Improperly disposing of waste can threaten the environment and ecology. Potentially harmful waste used with John Deere equipment include such items as oil, fuel, coolant, brake fluid, filters, and batteries.

Use leakproof containers when draining fluids. Do not use food or beverage containers that may mislead someone into drinking from them.

Do not pour waste onto the ground, down a drain, or into any water source.

Air conditioning refrigerants escaping into the air can damage the Earth's atmosphere. Government regulations may require a certified air conditioning service center to recover and recycle used air conditioning refrigerants.

Inquire on the proper way to recycle or dispose of waste from your local environmental or recycling center, or from your John Deere dealer.

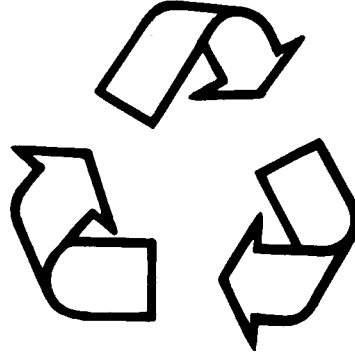

TS1133 -UN-26NOV90

DX,DRAIN -19-03MAR93-1/1

Live With Safety

Before returning machine to customer, make sure machine is functioning properly, especially the safety systems. Install all guards and shields.



TS231 -19-07OCT88

DX,LIVE -19-25SEP92-1/1

300D Specifications

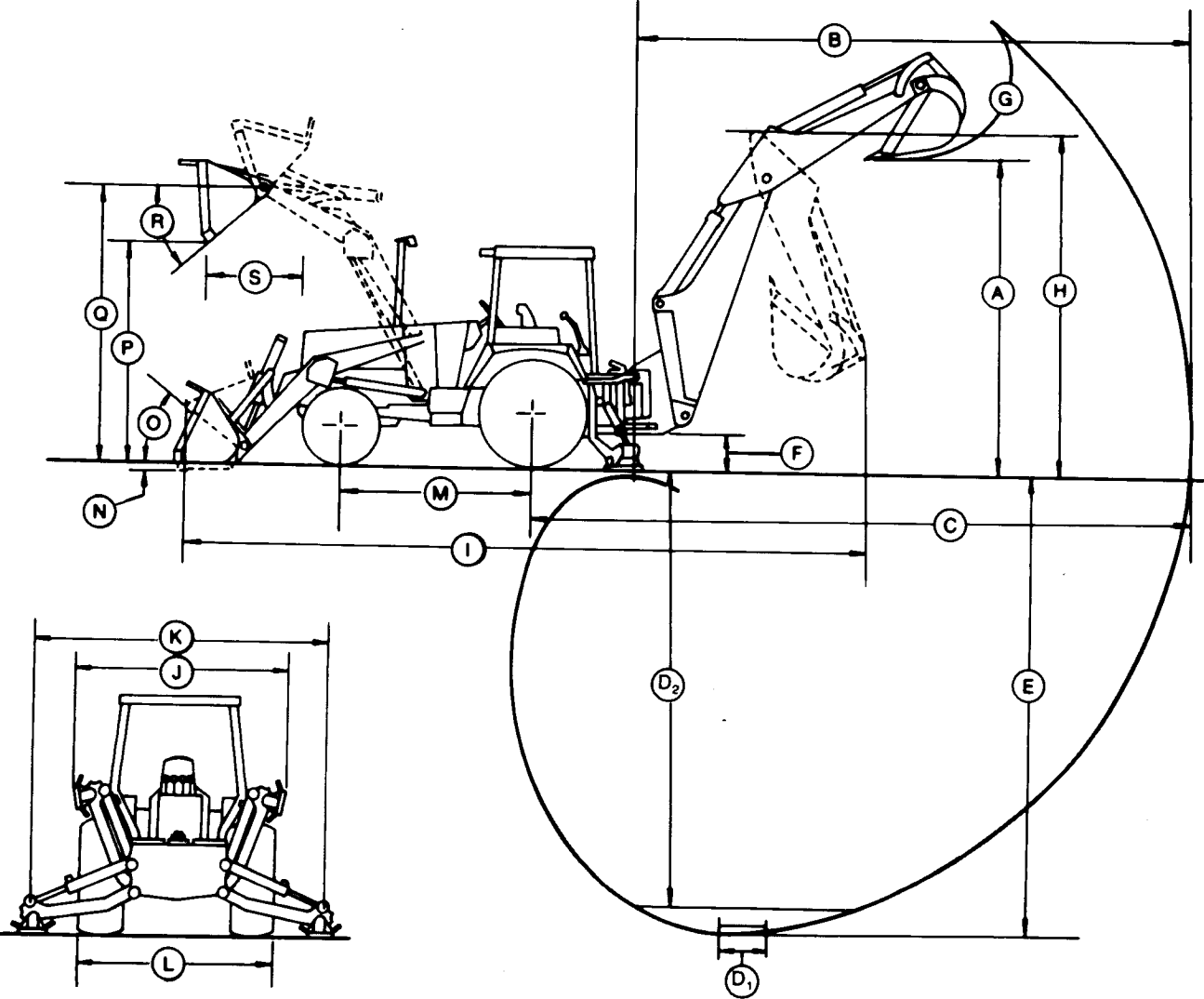

T7412AL -JUN-15NOV90

NOTE: Specifications and design subject to change without notice. Wherever applicable, specifications are in accordance with SAE Standards. Except where otherwise noted, these specifications are based on a standard machine with 16.9-24, 8PR, R4 rear tires;

11L-15, 8PR, F3 front tires with 75 percent CaCl₂ fill; 0.67 m³ (.88 cu. yd.) loader bucket; 610 mm (24 in.) backhoe bucket; ROPS/FOPS; full fuel tank and 79 kg (175 lb) operator.

TX115DH1384 -19-26SEP91-1/1

General Specifications

9000
02
2
300D Backhoe Loader

Key:	Backhoe		Extendible Dipperstick	
	Retracted	Extended		
A—Loading height, truck loading position	10 ft 9 in. (3.29 m)		11 ft 1 in. (3.37 m)	12 ft 9 in. (3.88 m)
B—Reach from center of swing mast	17 ft 3 in. (5.25 m)		17 ft 3 in. (5.25 m)	20 ft 10 in. (6.36 m)
C—Reach from center of rear axle	20 ft 7 in. (6.28 m)		20 ft 7 in. (6.28 m)	24 ft 3 in. (7.39 m)
D—Digging depth (SAE):				
(1) 2 ft (610 mm) flat bottom	13 ft 10 in. (4.21 m)		13 ft 10 in. (4.21 m)	17 ft 8 in. (5.38 m)
(2) 8 ft (2440 mm) flat bottom	12 ft 8 in. (3.87 m)		12 ft 8 in. (3.87 m)	16 ft 10 in. (5.13 m)
E—Maximum digging depth	14 ft (4.27 m)		14 ft (4.27 m)	17 ft 9 in. (5.41 m)
F—Ground clearance, minimum	13 in. (330 mm)		13 in. (330 mm)	13 in. (330 mm)
G—Bucket rotation	160° or 180°		160° or 180°	160° or 180°
H—Transport height	12 ft 0 in. (3.67 m)		12 ft 0 in. (3.67 m)	12 ft 0 in. (3.67 m)
I—Overall length, transport	22 ft 6 in. (6.85 m)		22 ft 6 in. (6.85 m)	22 ft 6 in. (6.85 m)
J—Stabilizer width, transport	7 ft 4 in. (2.23 m)		7 ft 4 in. (2.23 m)	7 ft 4 in. (2.23 m)
K—Stabilizer spread, operating	8 ft 11 in. (2.71 m)		8 ft 11 in. (2.71 m)	8 ft 11 in. (2.71 m)
L—Overall width (less loader bucket)	6 ft 11 in. (2.11 m)		6 ft 11 in. (2.11 m)	6 ft 11 in. (2.11 m)
Digging force, bucket cylinder (power dig position)	10225 lb (45.5 kN)		10250 lb (45.6 kN)	10225 lb (45.5 kN)
Digging force, crowd cylinder	5530 lb (24.6 kN)		5530 lb (24.6 kN)	3365 lb (15.0 kN)
Swing arc	180 degrees		180 degrees	180 degrees
Operator control	Two levers		Right foot treadle	Right foot treadle
Bucket positions	21° or 30° rollback		19° or 28° rollback	22° or 32° rollback
Stabilizer angle rearward	12°		12°	12°
Lifting capacity, maximum boom @ 65°	2700 lb (1225 kg)		2600 lb (1180 kg)	1550 lb (700 kg)

NOTE: Backhoe specifications are with 24-in. (610 mm) standard bucket.

Key:	Loader With 1.5 yd ³ (1.15 m ³) Bucket
M—Wheelbase	83 in. (2100 mm)
N—Dig below ground—bucket level	4 in. (100 mm)
O—Rollback at ground level	40°
P—Dump clearance, bucket at 40°	8 ft. 10 in. (2.69 m)
Q—Maximum height to bucket hinge pin	10 ft. 11 in. (3.33 m)
R—Maximum bucket dump angle	45°
S—Reach at full height, bucket at 40°	28 in. (711 mm)

TX,115,DH1385 -19-17APR93-1/1

300D Backhoe Loader (Continued)

NOTE: (Specifications and design subject to change without notice. Wherever applicable, specifications are in accordance with ICED and SAE Standards.)

Power	SAE
Net	60 hp (45 kW)

Engine:	
John Deere 4039D	
Rated power @ 2200rpm	60 SAE net hp (45 kW) 63 SAE gross hp (47 kW)
Cylinders	4
Displacement	239 cu. in. (3.91 L)
Maximum torque @ 1200 rpm	172 lb-ft (233 N•m)
Lubrication	Pressure system w/full-flow filter
Cooling	Pressurized w/thermostat and fixed bypass
Air cleaner	Dry
Electrical system	12-volt
Alternator	65 amps

Transmission:
John Deere 4-speed helical gear, synchronized collar shift transmission with hydraulic reverser. Torque converter 11 in (280 mm) with 2.78:1 stall ratio.

Travel Speeds:	Gear	Forward		Reverse	
		mph	km/h	mph	km/h
With Standard 16.9-24 rear and 11L-15 front tires	1	3.4	5.4	3.3	5.2
2	5.7	9.2	5.6	9.0	
3	12.3	19.8	12.2	19.6	
4	22.4	36.1	22.3	35.9	

Final Drives:
Heavy-duty inboard mounted planetary. Evenly distributes axle shock loads over three oil cooled gears.

Service Brakes:
Manual hydraulic, applied with separate pedals; hydraulically equalized when both pedals are depressed. Wet disks and facings are fully enclosed and self-adjusting.

Park Brake:
Independent system, spring applied, hydraulically released, and controlled by an electric switch on the side console.

Steering: Hydrostatic Power	
Non-powered axle curb turning radius	
(brakes applied)	12 ft 0 in. (3.67 m)
(without brakes)	13 ft 2 in. (4.00 m)
Bucket clearance circle	
(brakes applied)	32 ft 5 in. (9.89 m)
(without brakes)	34 ft 7 in. (10.55 m)
Steering wheel turns	
Stop to stop	2.2 to 2.9
Powered axle (MFWD) curb turning radius	
(brakes applied)	11 ft 9 in. (3.57 m)
(without brakes)	13 ft 5 in. (4.10 m)
Bucket clearance circle	
(brakes applied)	30 ft 9 in. (9.38 m)
(without brakes)	34 ft 3 in. (10.44 m)
Steering wheel turns	
Stop to stop	2.5

Hydraulic System: Open center	
Pressure setting	2700 psi (18 620 kPa)
Pump	Gear type
Flow @ 2200 rpm	24 gpm (91 L/min)
Filter, return oil	10 micron replaceable element

Tires:	
Front	11L-15, 8PR, F3
With MFWD	12-16.5, 8 PR
Rear	16.9—24 8PR, R4 17.5L—24 8PR, R4
With MFWD	16.9—24 8PR R4A

General Specifications

9000
02
4

Transporting:	
SAE operating weight with ROPS	12,200 lb (5533 kg)
Cab adds	500 lb (227 kg)
MFWD w/tires adds	220 lb (100 kg)
Extendible dipperstick adds	360 lb (163 kg)
Optional front counterweight	370 lb (169 kg)
Optional front counterweight	770 lb (349 kg)

TX,115,DH1388 -19-22JUL99-2/2

300D Backhoe Loader Buckets

Loader:	Width mm (in.)	Heaped Capacity m³(Cu Yd)	Weight kg (lb)
General purpose	2057 (81)	0.67 (0.88)	249 (550)
2340 (92)	0.76 (1.00)	367 (810)	
Multi-purpose	2134 (84)	0.86 (1.12)	345 (760)

Backhoe:	Width mm (in.)	Heaped Capacity m³(Cu Yd)	Weight kg (lb)
Standard	305 (12)	0.07 (2.5)	111 (244)
406 (16)	0.10 (3.6)	122 (268)	
457 (18)	0.12 (4.1)	126 (278)	
610 (24)	0.17 (6.0)	149 (328)	
762 (30)	0.22 (7.9)	165 (364)	
914 (36)	0.28 (10.0)	195 (439)	
Heavy	305 (12)	0.07 (2.5)	117 (258)
Duty	457 (18)	0.14 (5.1)	137 (302)
610 (24)	0.17 (6.0)	151 (334)	
610 (24)	0.21 (7.5)	158 (348)	
Extra	457 (18)	0.14 (5.1)	164 (362)
Heavy	610 (24)	0.21 (7.5)	192 (424)
Duty	762 (30)	0.28 (10.0)	215 (474)

TX,115,DH1386 -19-17APR93-1/1

300D Backhoe Loader Drain And Refill Capacities

	Metric	U.S.
Engine coolant	16 L	17 qt
Engine oil (including filter)	8.5 L	9 qt
Torque converter and reverser	7.5 L	8 qt
Transaxle		
(without MFWD)	21 L	22 qt
(with MFWD)	22 L	23 qt
Fuel tank		
Serial No. —802199	106 L	28 gal
Serial No. 802200—	129 L	34 gal
Hydraulic system reservoir	41.5 L	44 qt

TX,115,DH1387 -19-12OCT94-1/1

9000
02
6

300D Backhoe Loader Lifting Capacities—KG (LB)

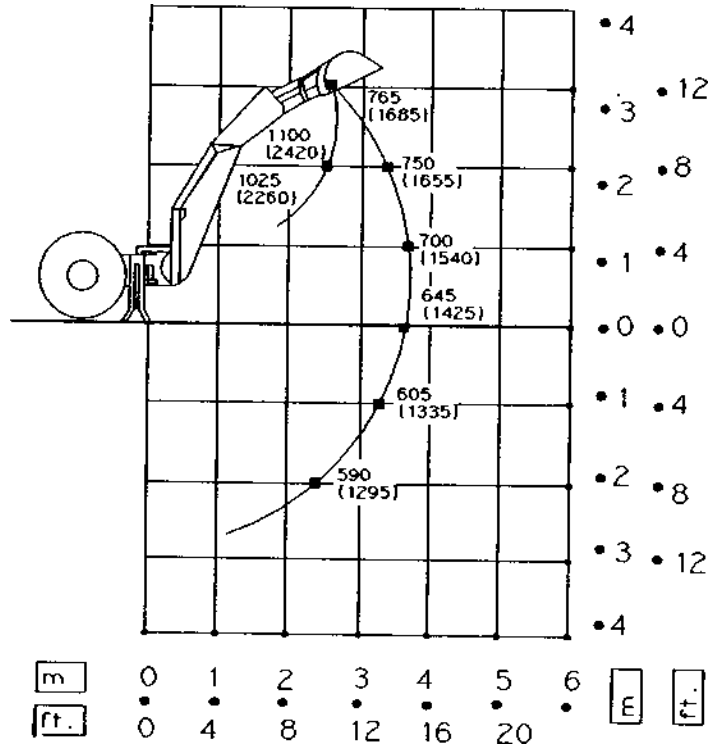

Lift Capacity, Backhoe With Standard Dipperstick Based On SAE J31 (Except With Loader Bucket On Ground)

T7634AA -JUN-18OCT91

Continued on next page

TX,115,DH1390 -19-29OCT91-1/3

General Specifications

9000
02
7

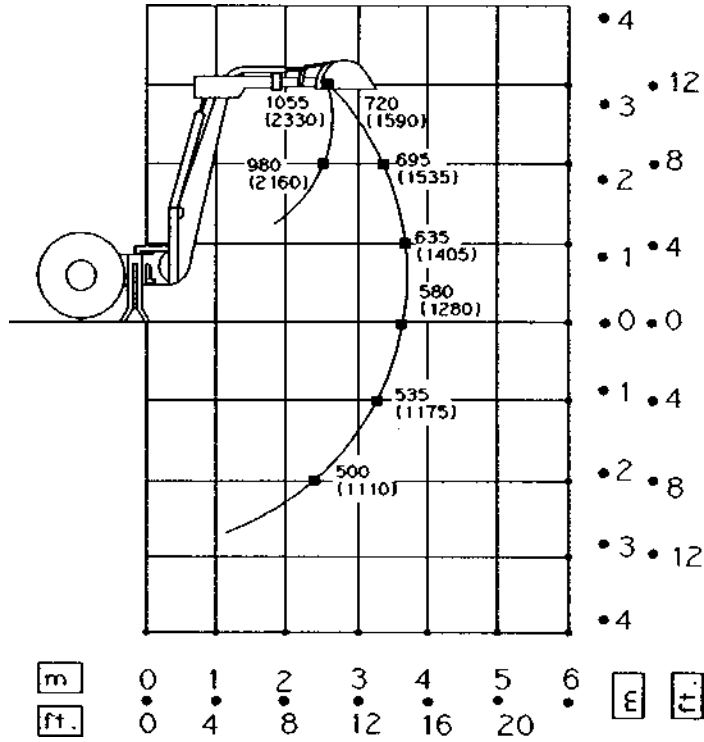

T7634AB -JUN-18OCT91

Lift Capacity, Backhoe With Extendible Dipperstick, Retracted Based On SAE J31 (Except With Loader Bucket On Ground)

Continued on next page

TX,115,DH1390 -19-29OCT91-2/3

General Specifications

9000
02
8

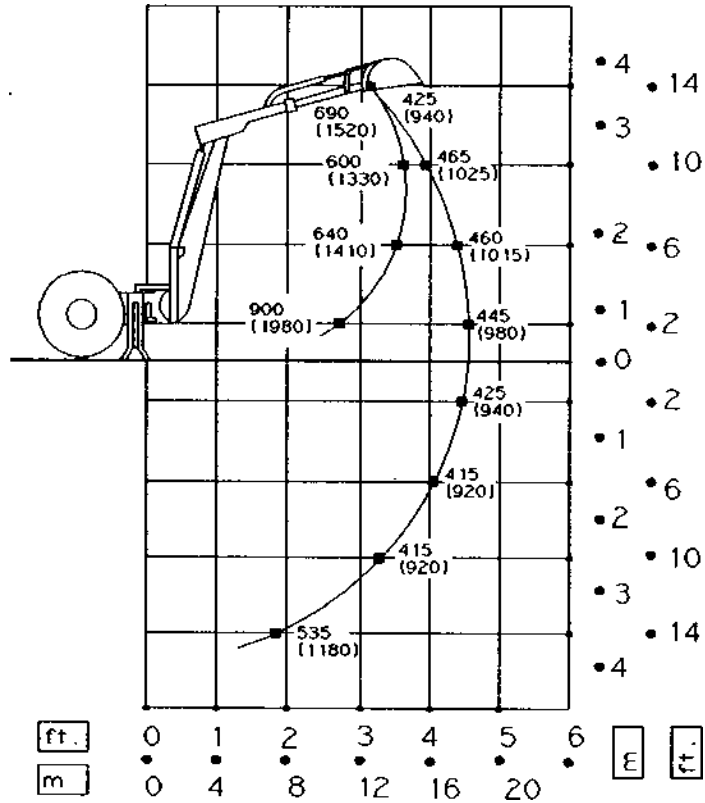

T7634AC -JUN-18OCT91

Lift Capacity, Backhoe With Extendible Dipperstick, Extended Based On SAE J31 (Except With Loader Bucket On Ground)

Lifting capacity ratings are made with bucket hinge pin, loader bucket, and stabilizers on firm, level ground. Lift capacities are hydraulically limited. Lifting capacities are 87 percent of the maximum lift over any point on the swing arc and do not exceed 75 percent of the tipping load. Angle between boom and ground is 65 degrees. Machine is equipped with 610 mm (24 in.)

standard bucket, standard or extendible dipperstick and standard equipment.

NOTE: Loader bucket on ground significantly improves side stability, therefore improving lift capacity to the side. Lift capacity over the rear is not affected.

TX,115,DH1390 -19-29OCT91-3/3

310D Specifications

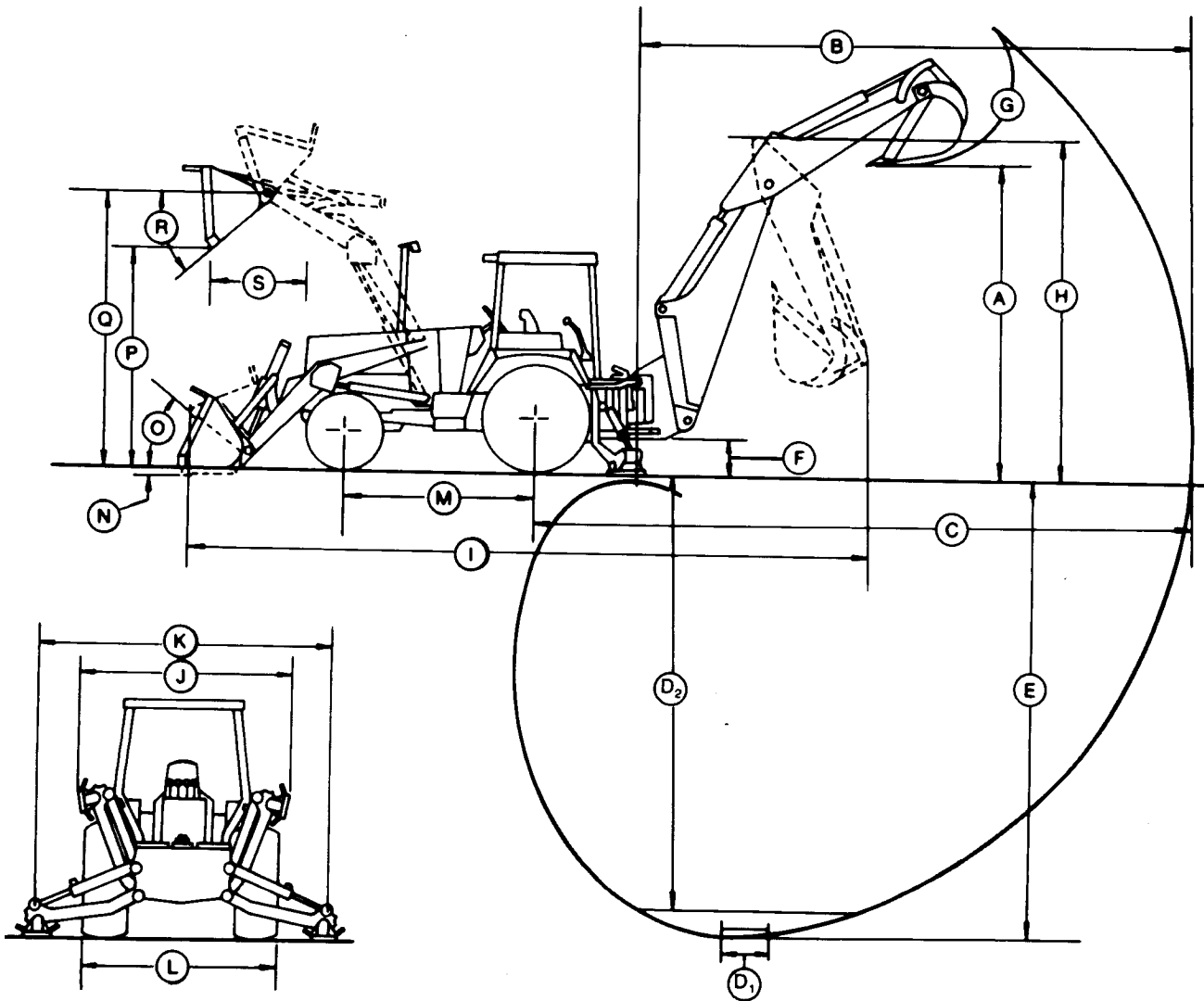

T7412AL -JUN-15NOV/90

NOTE: Specifications and design subject to change without notice. Wherever applicable, specifications are in accordance with SAE Standards. Except where otherwise noted, these specifications are based on a standard machine with 17.5L-24, 10PR, R4 rear tires;

11L-15, 8PR, F3 front tires with 75 percent CaCl₂ fill; 0.76 m³ (1.0 cu. yd.) loader bucket; 610 mm (24 in.) backhoe bucket; ROPS/FOPS; full fuel tank and 79 kg (175 lb) operator.

TX,115,DH1393 -19-26SEP91-1/1

General Specifications

9000
02
10
310D Backhoe Loader

Key:	Backhoe		Extendible Dipperstick	
	Retracted	Extended		
A—Loading height, truck loading position	11 ft 4 in. (3.45 m)	11 ft 8 in. (3.55 m)	13 ft 11 in. (4.24 m)	
B—Reach from center of swing mast	17 ft 7 in. (5.36 m)	17 ft 7 in. (5.36 m)	21 ft 3 in. (6.47 m)	
C—Reach from center of rear axle	21 ft 0 in. (6.40 m)	21 ft 0 in. (6.40 m)	24 ft 7 in. (7.50 m)	
D—Digging depth (SAE):				
(1) 2 ft (610 mm) flat bottom	14 ft 4 in. (4.37 m)	14 ft 4 in. (4.37 m)	18 ft 2 in. (5.53 m)	
(2) 8 ft (2440 mm) flat bottom	13 ft 2 in. (4.02 m)	13 ft 2 in. (4.02 m)	17 ft 4 in. (5.28 m)	
E—Maximum digging depth	14 ft 6 in. (4.42 m)	14 ft 6 in. (4.42 m)	18 ft 3 in. (5.56 m)	
F—Ground clearance, minimum	13 in. (330 mm)	13 in. (330 mm)	13 in. (330 mm)	
G—Bucket rotation	160° or 180°	160° or 180°	160° or 180°	
H—Transport height	12 ft 0 in. (3.67 m)	12 ft 2 in. (3.72 m)	12 ft 2 in. (3.72 m)	
I—Overall length, transport	22 ft 7 in. (6.88 m)	22 ft 7 in. (6.88 m)	22 ft 7 in. (6.88 m)	
J—Stabilizer width, transport	7 ft 0 in. (2.12 m)	7 ft 0 in. (2.12 m)	7 ft 0 in. (2.12 m)	
K—Stabilizer spread, operating	10 ft 0 in. (3.05 m)	10 ft 0 in. (3.05 m)	10 ft 0 in. (3.05 m)	
L—Overall width (less loader bucket)	7 ft 1 in. (2.15 m)	7 ft 1 in. (2.15 m)	7 ft 1 in. (2.15 m)	
Digging force, bucket cylinder (power dig position)	11570 lb (51.5 kN)	11530 lb (51.3 kN)	11530 lb (51.3 kN)	
Digging force, crowd cylinder	6650 lb (29.6 kN)	6700 lb (29.8 kN)	4550 lb (20.2 kN)	
Swing arc	180 degrees	180 degrees	180 degrees	
Operator control	Two levers	Right foot treadle	Right foot treadle	
Bucket positions	12° or 21° rollback	8° or 17° rollback	13° or 21° rollback	
Stabilizer angle rearward	13°	13°	13°	
Lifting capacity, maximum boom @ 65°	4600 lb (2087 kg)	4400 lb (1996 kg)	2700 lb (1225 kg)	

NOTE: Backhoe specifications are with 24-in. (610 mm) standard bucket.

Key:	Loader With 1.5 yd ³ (1.15 m ³) Bucket
M—Wheelbase	83 in. (2100 mm)
N—Dig below ground—bucket level	4 in. (100 mm)
O—Rollback at ground level	40°
P—Dump clearance, bucket at 40°	8 ft. 10 in. (2.69 m)
Q—Maximum height to bucket hinge pin	10 ft. 10 in. (3.30 m)
R—Maximum bucket dump angle	45°
S—Reach at full height, bucket at 40°	28 in. (711 mm)

310D Backhoe Loader (Continued)

NOTE: (Specifications and design subject to change without notice. Wherever applicable, specifications are in accordance with ICED and SAE Standards.)

Engine:	
John Deere 4039D and 4039T	
Rated power @ 2200 rpm (Naturally aspirated)	SAE net 67 hp (50 kW)
Rated power @ 2200 rpm (Turbocharged)	SAE net 72 hp (53.7 kW)
Cylinders	4
Displacement	239 cu. in. (3.91 L)
Torque rise at 1200 rpm	
with turbocharger	25%
without turbocharger	20%
Lubrication	Pressure system w/full-flow filter
Cooling	Pressurized w/thermostat and fixed bypass
Air cleaner	Dry
Electrical system	12-volt
Alternator	78 amps

Transmission:
John Deere 4-speed helical gear, synchronized collar shift transmission with hydraulic reverser. Torque converter 11 in. (280 mm) with 2.83:1 stall ratio.

Travel Speeds:	Gear	Forward		Reverse	
		mph	km/h	mph	km/h
With Standard 17.5L-24 rear and 11L-15 front tires	1	3.3	5.3	3.0	4.8
	2	5.7	9.2	5.1	8.2
	3	12.3	19.8	11.1	17.9
	4	22.4	36.1	20.2	32.5
With MFWD and required 19.5L-24 rear and 12-16.5 front tires	1	3.4	5.5	3.1	5.0
	2	5.9	9.5	5.3	8.5
	3	12.6	20.3	11.3	18.2
	4	23.0	37.0	20.7	33.3

Final Drives:
Heavy-duty inboard mounted planetary. Evenly distributes axle shock loads over three oil cooled gears.

Continued on next page

TX,115.DH1397 -19-22JUL99-1/2

General Specifications

9000
02
12

Service Brakes:

Manual hydraulic, applied with separate pedals; hydraulically equalized when both pedals are depressed. Wet disks and facings are fully enclosed and self-adjusting.

Park Brake:

Independent system, spring applied, hydraulically released, and controlled by an electric switch on the side console.

Steering: Hydrostatic Power

Non-powered axle curb turning radius

(brakes applied)	11 ft 9 in. (3.57 m)
(without brakes)	13 ft 3 in. (4.04 m)

Bucket clearance circle

(brakes applied)	31 ft 6 in. (9.61 m)
(without brakes)	34 ft 7 in. (10.55 m)

Steering wheel turns

Stop to stop	2.2 to 2.9
--------------	------------

Powered axle (MFWD) curb turning radius

(brakes applied)	10 ft 11 in. (3.34 m)
(without brakes)	13 ft 8 in. (4.17 m)

Bucket clearance circle

(brakes applied)	29 ft 9 in. (9.07 m)
(without brakes)	35 ft 3 in. (10.74 m)

Steering wheel turns

Stop to stop	2.5
--------------	-----

Hydraulic System: Open center

Pressure setting	2700 psi (18 620 kPa)
Pump	Gear type
Flow @ 2200 rpm	35 gpm (133 L/min)
Filter, return oil	10 micron replaceable element

Tires:

Front	11L-15, 8PR, F3 11L-16, 12PR, F3
With MFWD	12-16.5, 8PR 14-17.5, 8PR, NHS
Rear	16.9-24 8PR, R4 17.5L-24 10PR, R4 19.5L-24, 8PR R4
With MFWD	19.5-24 8PR R4 21L-24, 10 PR R4



DH1397 -19-22JUL99-2/2

310D Buckets

Loader:	Width In. (mm)	Heaped Capacity Cu. Yd. (m ³)	Weight lb (kg)
General Purpose	92 (2340)	1.00 (0.76)	760 (345)
92 (2340)	1.30 (1.00)	800 (363)	
Long Lip Multi-purpose	89 (2270)	1.25 (0.96)	750 (340)
92 (2340)	1.25 (0.96)	1560 (708)	

Backhoe:	Width In. (mm)	Heaped Capacity Cu. Ft. (m ³)	Weight lb (kg)
Standard	12 (305)	2.5 (0.07)	244 (111)
16 (406)	3.6 (0.10)	268 (122)	
18 (457)	5.1 (0.14)	322 (146)	
24 (610)	7.5 (0.21)	370 (168)	
30 (762)	10.0 (0.28)	410 (186)	
36 (914)	9.9 (0.28)	430 (195)	
36 (914)	14.5 (0.41)	556 (252)	
Heavy	12 (305)	2.5 (0.07)	258 (117)
Duty	18 (457)	5.1 (0.14)	334 (151)
24 (610)	7.5 (0.21)	396 (180)	
24 (610)	8.8 (0.25)	476 (216)	
30 (762)	10.0 (0.28)	444 (201)	
36 (914)	10.0 (0.28)	480 (217)	
Extra	18 (457)	5.1 (0.14)	362 (164)
Heavy	24 (610)	7.5 (0.21)	424 (192)
Duty	30 (762)	10.0 (0.28)	474 (215)

Transporting:	
SAE operating weight with ROPS	13,600 lb (6169 kg)
Cab added	500 lb (227 kg)
MFWD w/tires added	220 lb (100 kg)
Extendible dipperstick	430 lb (195 kg)
Optional front counterweight	770 lb (349 kg)
Optional front counterweight	200 lb (91 kg)

General Specifications

9000
02
14

310D Drain And Refill Capacities

	Metric	U.S.
Engine coolant	16 L	17 qt
Engine oil (including filter)	8.5 L	9 qt
Torque converter and reverser	7.5 L	8 qt
Transaxle		
(without MFWD)	21 L	22 qt
(with MFWD)	22 L	23 qt
Fuel tank		
Serial No. —802199	106 L	28 gal
Serial No. 802200—	129 L	34 gal
Hydraulic system reservoir	41.5 L	44 qt

TX,115,DH1396 -19-12OCT94-1/1

310D Backhoe Loader Lifting Capacities—KG (LB)

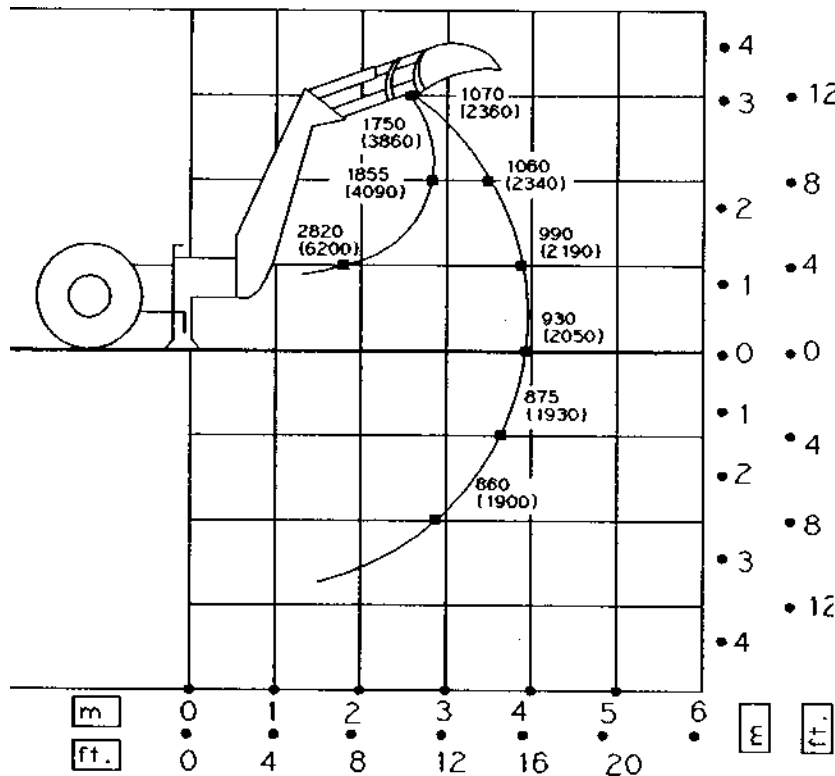

Lift Capacity, Backhoe With Standard Dipperstick Based On SAE J31 (Except With Loader Bucket On Ground)

T7634AD -JUN-18OCT91

Continued on next page

TX,115,DH1398 -19-29OCT91-1/3